

USER MANUAL

MODEL:

**VIA Campus², VIA Campus² PLUS
Presentation & Collaboration Solution
(For Firmware Version 2.5)**



Contents

Introduction	1
Getting Started	1
Overview	2
Supported Devices	4
Defining VIA Campus² Presentation & Collaboration Solution	5
For Installer: Mounting VIA Campus²	7
For Installer: Connecting VIA Campus²	8
Connecting Device	8
Connecting Main Display	9
For Web Administrator: Configuring Settings – Embedded Web Pages	11
Logging in to Embedded Web Pages	12
Configuring VIA Gateway Settings	13
Managing Network Settings	25
Managing User Access	28
Managing VIA Features	36
Customizing Main Display Look and Feel	48
Maintaining Your VIA Unit	57
Configuring Digital Signage	62
For Web Administrator: Configuring Settings – Gateway Dashboard	76
Logging in to Gateway Dashboard Settings	76
Changing LAN Settings	77
Enabling a Second Network	78
Accessing System Controls	78
For User: Running Kramer VIA App	80
Running Kramer VIA App for PC and Mac	80
Running Kramer VIA App for Tablets & Smartphones	80
Running Kramer VIA App for Chromebooks/Chrome Web Browser	81
Running Kramer VIA App Using an Installation File	85
For User: Participating in a VIA Meeting	86
Joining a VIA Meeting	86
Mirroring Your Device Screen	93
Collaborating on Main Display	99
Streaming Video	109
Communicating with Participants	117
Mirroring Main Display on Your Device	126
Advanced Meeting Functions	127
Technical Specifications	137

Introduction

Welcome to Kramer Electronics! Since 1981, Kramer Electronics has been providing a world of unique, creative, and affordable solutions to the vast range of problems that confront the video, audio, presentation, and broadcasting professional on a daily basis. In recent years, we have redesigned and upgraded most of our line, making the best even better!

Getting Started

We recommend that you:

- Unpack the equipment carefully and save the original box and packaging materials for possible future shipment.
- Review the contents of this user manual.



Go to [www.kramerav.com/downloads/VIA Campus²](http://www.kramerav.com/downloads/VIA_Campus2) to check for up-to-date user manuals, application programs, and to check if firmware upgrades are available (where appropriate).

Achieving Best Performance

- Use only good quality connection cables (we recommend Kramer high-performance, high-resolution cables) to avoid interference, deterioration in signal quality due to poor matching, and elevated noise levels (often associated with low quality cables).
- Do not secure the cables in tight bundles or roll the slack into tight coils.
- Avoid interference from neighboring electrical appliances that may adversely influence signal quality.
- Position your Kramer **VIA Campus²** away from moisture, excessive sunlight and dust.



This equipment is to be used only inside a building. It may only be connected to other equipment that is installed inside a building.

Safety Instructions



Caution: There are no operator serviceable parts inside the unit

Warning: Use only the Kramer Electronics power supply that is provided with the unit

Warning: Disconnect the power and unplug the unit from the wall before installing

Recycling Kramer Products

The Waste Electrical and Electronic Equipment (WEEE) Directive 2002/96/EC aims to reduce the amount of WEEE sent for disposal to landfill or incineration by requiring it to be collected and recycled. To comply with the WEEE Directive, Kramer Electronics has made arrangements with the European Advanced Recycling Network (EARN) and will cover any costs of treatment, recycling and recovery of waste Kramer Electronics branded equipment on

arrival at the EARN facility. For details of Kramer's recycling arrangements in your particular country go to our recycling pages at www.kramerav.com/support/recycling.

Overview



Unless otherwise noted, when **VIA Campus²** is mentioned it refers to both **VIA Campus²** and **VIA Campus² PLUS**.

VIA Campus² is a wireless presentation and collaboration solution that makes it easier to get actual work done during meetings. With any laptop or mobile device, users can view, edit and comment on documents in real time and record sessions. Meeting participants can display or stream full uninterrupted HD video (up to 1080p60) from their device, and even play YouTube[®] videos in full frame rate. In addition to wireless connection, **VIA Campus² PLUS** also features an HDMI[™] wired input.

VIA Campus² can show up to six user screens on a single main display and 12 on two displays. Users can also view the main display on their own device. **VIA Campus²** features iOS mirroring for MacBook, iPad, and iPhone, as well as mirroring for Chromebook and Android (Lollipop OS 5.0 or newer).

VIA Campus² supports 3rd party conferencing and office apps, such as Microsoft Office[®], Skype[®], GoToMeeting[®], Teams[®], and WebEx[®]. The solution can handle any size collaboration or meeting space and is ideal for training venues and classrooms.

Key Features

- Wireless Device Connectivity – No dongle needed.
- HDMI Wired Input (**VIA Campus² PLUS** only) – Enables hard-wiring your computer or other HDMI compatible device such as a camera, multimedia player or computer.



Does not support HDCP signals.

- Windows 10 Operating System.
- 60fps Streaming Multimedia – Share HD wireless video streaming (using the VIA app Multimedia feature).
- Wireless Connection for up to 254 Devices – Utilizing Compatible External Wireless Network.
- iOS, Android, Chromebook Mirroring.
- Room Calendar Integration – Shows the room occupancy schedule on the main display.
- Internal Web Browser – Open any browser to display content.
- DHCP Support.
- 4K Support – Present 4K content to compatible 4K displays.
- Streaming Input for the Internal Media Player.
- Cloud-Based File Sharing – Drag and drop files to the internal VIA cloud storage (128GB).

- Emergency Messages – Create instant alert messages for immediate push to the main display (requires VSM).
- Whiteboard Support.
- Control – Give a participant control over a presenter's PC for true collaboration.
- Chat – Send an instant message to another user.
- iCloud®, OneDrive®, GoogleDrive®, Dropbox® Integration.
- View Main Display – View the main display on your own device.
- Third-Party App Support – Like Microsoft Office®, Skype®, GoToMeeting® and WebEx®.
- Icon Shortcuts – On the splash page for third party applications.
- Integrated YouTube Player – Create playlists, share videos or drag and drop any YouTube clip to your VIA app for seamless video playback.
- Streaming Output – Stream all collaboration activity from the main display to any H.264 decoder.
- Recording – Record an entire VIA video and audio session to a local video file.
- Digital Signage – Display dynamic content on the main display during meeting downtime.
- Seamless VSM Integration – With VIA Site Management (VSM) software.
- Multilingual Support – Experience VIA in your language.

Typical Applications

- Boardrooms.
- Conference rooms.
- Presentation rooms.
- Collaboration spaces.
- Corporate and university training rooms.
- Classrooms and lecture halls.

Supported Devices

The following user devices are supported by the **VIA Campus² Presentation & Collaboration Solution**:

- Windows 7/8/10[®] (32-bit/64-bit) computer.
- Macintosh[®] computer, using OSX 10.11.x or newer.
- Chromebook.
- iPad/iPhone[®] tablet/smartphone (iPad 2 or later, iOS 10 or later).



When using the Airplay service, no Kramer VIA application is needed. However, we recommend using iOS12 or Mojave OS X for a better experience.

- Android[®] OS 5. x tablet/smartphone or newer.



The minimum system requirement for using the **Kramer VIA** mirroring feature for an Android device is Android 5.1.

Defining VIA Campus² Presentation & Collaboration Solution

This section defines VIA Campus².

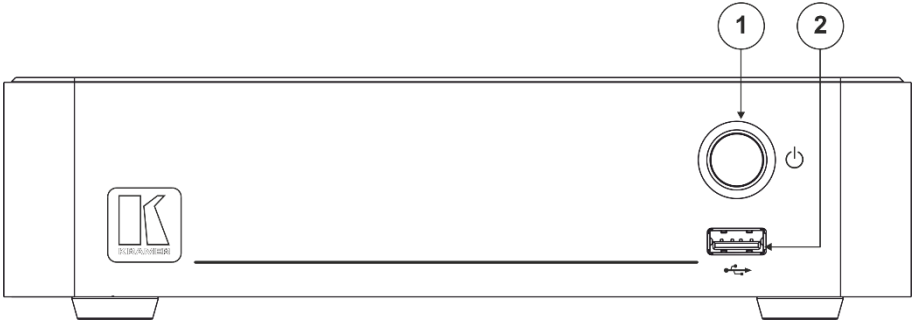

Figure 1: VIA Campus² and VIA Campus2 PLUS Front

#	Feature	Function
①	Power Button	For turning the machine on and off. Button lights when the unit is turned on.
②	USB 2.0 Connector	For connecting a USB device.

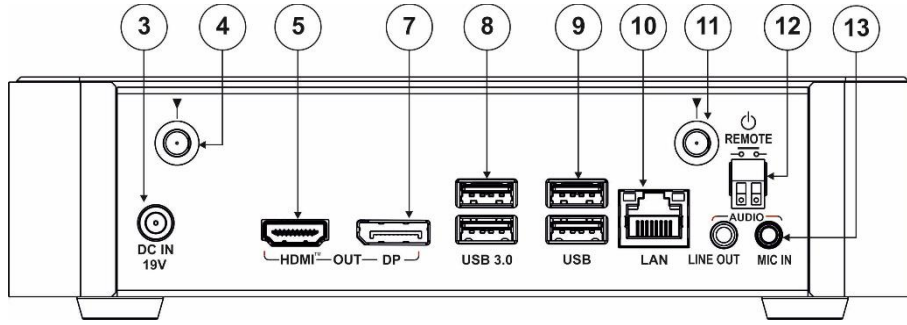

Figure 2: VIA Campus² Back

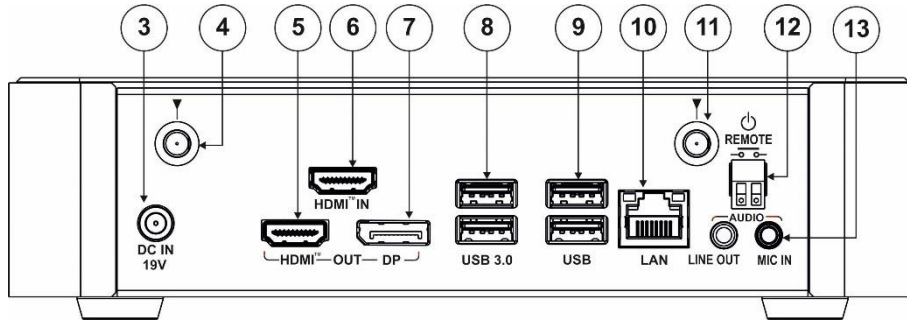

Figure 3: VIA Campus² PLUS Back

#	Feature	Function
③	DC IN 19V Connector	Connects to the 19V DC power adapter.
④	Wi-Fi Antenna Port (1 of 2)	Connect one of the Wi-Fi antennas for collaborating via the built-in Wi-Fi.
⑤	HDMI OUT Connector	Connect to an HDMI display.
⑥	HDMI IN Connector	Connect to an HDMI source (for example, a laptop).
⑦	DP OUT Connector	Connect to a DisplayPort display.
⑧	USB 3.0 Connectors	Connect to up to 2 USB devices.
⑨	USB 2.0 Connectors	Connect to up to 2 USB devices.
⑩	LAN RJ-45 Connector	Connect a Local Area Network (LAN) cable
⑪	Wi-Fi Antenna Port (2 of 2)	Connect one of the Wi-Fi antennas for collaborating via the built-in Wi-Fi.
⑫	REMOTE 2-pin Terminal Block	Connect to a toggle switch to remotely turn the device on and off.
⑬	AUDIO	
	LINE OUT 3.5mm Mini Jack	Connect to an unbalanced stereo audio acceptor.
	MIC IN 3.5mm Mini Jack	Connect to a microphone.

For Installer: Mounting VIA Campus²

This section provides instructions for mounting **VIA Campus²**. Before installing, verify that the environment is within the recommended range:



- Operation temperature – 0° to 40°C (32 to 104°F).
- Storage temperature – -40° to +70°C (-40 to +158°F).
- Humidity – 10% to 90%, RHL non-condensing.



- **VIA Campus²** must be placed upright in the correct horizontal position.



Caution:

- Mount **VIA Campus²** before connecting any cables or power.



Warning:

- Ensure that the environment (e.g., maximum ambient temperature & air flow) is compatible for the device.
- Avoid uneven mechanical loading.
- Appropriate consideration of equipment nameplate ratings should be used for avoiding overloading of the circuits.
- Reliable earthing of rack-mounted equipment should be maintained.

To mount VIA Campus² on a rack:

Mount the unit in a rack using the recommended rack adapter
(see [www.kramerav.com/product/VIA Campus²](http://www.kramerav.com/product/VIA_Campus2))

You can also install VIA Campus² using the following method :

- Place the device on a flat surface.

For Installer: Connecting VIA Campus²

- i** Always switch off the power to each device before connecting it to your **VIA Campus²**. After connecting your **VIA Campus²**, connect its power and then switch on the power to each device.

Connecting Device

- i** For illustration purposes, the diagram shows connections for **VIA Campus² PLUS**. The connections for **VIA Campus²** are the same, except for the HDMI IN connector.

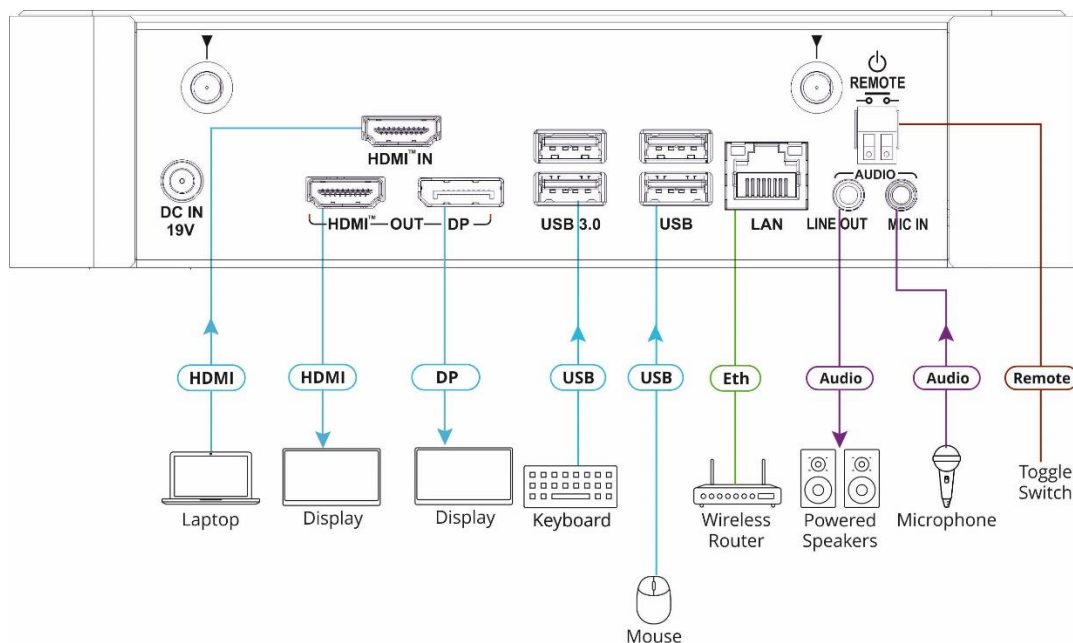

Figure 4: Connecting to the **VIA Campus² PLUS** Rear Panel

To connect the **VIA Campus²** as illustrated in [\(Figure 4\)](#):

1. Connect the keyboard and mouse to the USB Connectors **(8)** and **(9)**.
2. Connect one of the following to be used as the main display for the meeting (see [Connecting Main Display](#) on page [9](#)):
 - HDMI display to the HDMI OUT Connector **(5)**.
 - DisplayPort display to the DisplayPort Connector **(7)**

i A touchscreen display is best for annotation.

3. Connect a laptop or other HDMI source to the HDMI IN Connector **(6)** (see [Showing Content from External Wired Device](#) on page [104](#)).

4. Connect a Local Area Network (LAN) cable to the LAN RJ-45 Connector (10) for connection to your network.
5. Connect the Wi-Fi antennas to the Wi-Fi Antenna Ports (4) and (11) for using the built-in wireless capability.

 **VIA Campus²** can be connected to a local area network (LAN). In this setup, the default IP setting is DHCP that assigns an automatic IP address to your unit. This enables easy Plug and Play setup when connecting your **VIA Campus²** to the network. To assign a static IP address, see [Changing LAN Settings](#) on page 77.

6. Connect powered speakers and a microphone to the AUDIO Mini Jacks (13).
7. Connect the 19V DC power adapter to the Power Connector (4) and plug it into the mains electricity.

 Do not turn the device on before connecting the LAN port to the network.

8. Connect via Wi-Fi with any of the following types of devices:

 To enable participation in a collaborative session (send and receive content), all participant devices (PCs/ MACs/ smartphones/tablets) must be connected to the same network (LAN - wired/wireless) as the **VIA Campus²**.

- A Windows 7/8/10[®] (32-bit/64-bit) computer
- A Macintosh[®] computer, using OSX 10.11.x or newer
- An iPad/iPhone[®] tablet/smartphone with the VIA app installed (iPad 2 or later, iOS 10 or later)

 When using the Airplay service, no application is needed. However, we recommend using iOS 12 or Mojave OSX for a better experience.

- An Android[®] OS 5.x tablet/smartphone with the VIA app installed.

 For using the Android mirroring feature, a device equipped with Android 5.1 minimum is required.

9. Connect a USB device to the USB 2.0 Connector (2) on the front panel.

VIA Campus² is connected.

Connecting Main Display

The main display is the screen connected directly to **VIA Campus²**. When **VIA Campus²** is booted up, the VIA gateway screen appears on the main display. All collaboration activity is then displayed here. **VIA Campus²** enables connecting one or both of the following types of displays:

- HDMI – The HDMI OUT Connector (5) connects to any compatible projection or direct-view display, such as an LCD monitor. This connection can be routed and switched.
- DisplayPort – The DisplayPort Connector (7) connects to a DisplayPort display or to a

VGA display by means of a DP to VGA adapter cable.

VIA Campus²'s internal video card reads the EDID (Extended Display Identification Data) for any connected display and sets the optimum display resolution and image refresh rate automatically through the HDMI and DisplayPort jacks.



For more information on configuring the behavior of the displays when you use two displays simultaneously, see [Configuring Dual Displays](#) on page [20](#).

For Web Administrator: Configuring Settings – Embedded Web Pages

VIA Campus² enables users with Web Administrator access to configure settings for your VIA Campus² unit.

VIA Campus² enables you to do the following:

- [Logging in to Embedded Web Pages](#) on page [12](#).
- [Configuring VIA Gateway Settings](#) on page [13](#).
- [Managing Network Settings](#) on page [25](#).
- [Managing User Access](#) on page [28](#).
- [Managing VIA Features](#) on page [36](#).
- [Customizing Main Display Look and Feel](#) on page [48](#).
- [Maintaining Your VIA Unit](#) on page [57](#).
- [Configuring Digital Signage](#) on page [62](#).

Logging in to Embedded Web Pages

The embedded web pages enable you to configure your **VIA Campus²** unit. The embedded web pages are accessed from any computer through the Internet or your local network.

To log in to the **VIA Campus²** embedded web pages:

1. Open a Web browser and go to the IP address for your **VIA Campus²** unit.
The embedded web pages Welcome page appears.

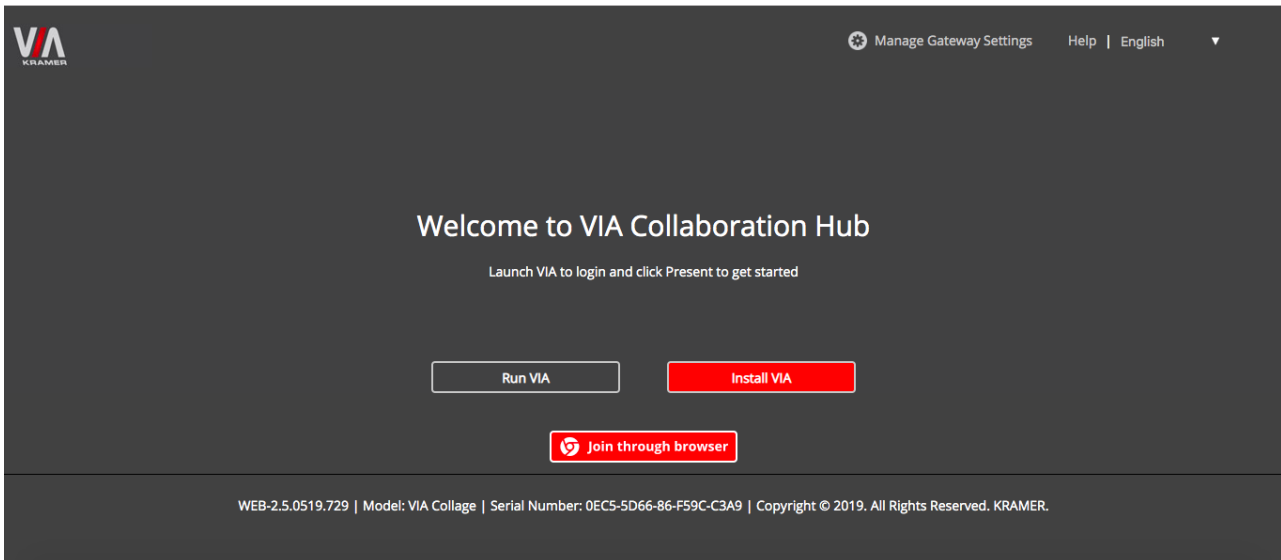

Figure 5: Embedded Web Pages Welcome Page

2. Click **Manage Gateway Settings** in the upper right corner.
The Administrator Login page appears.

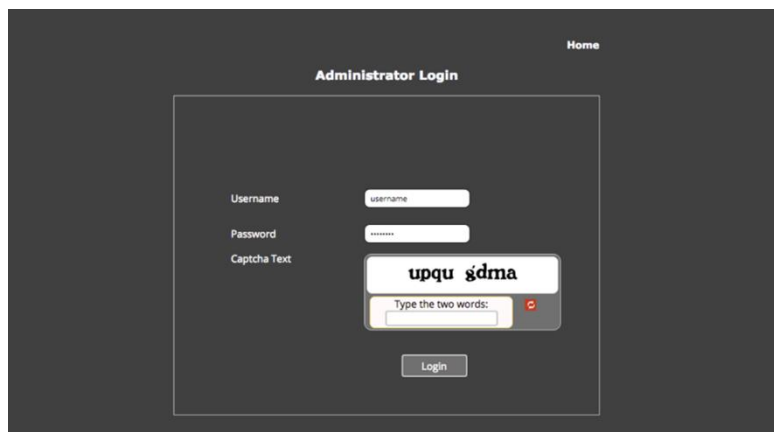

Figure 6: Embedded Web Pages – Administrator Login Page

3. Type a Web Administrator Username (default = su) and Password (default = supass).



You must log in as a user with Web Administrator user role to access settings through the embedded web pages (see [Creating New Users](#) on page 28).

4. Type the two Captcha Text strings with a space between them in the text box.



You can change the Captcha Text by clicking the refresh button to the right of the text box.

5. Click **Login**.
The Home page appears.

The screenshot shows the 'System Information' page. On the left is a navigation pane with the following items: Redirect To VIA Server, Home (selected), System Information, Help, Support, User Management, VIA Management, ePolling, Recording, Digital Signage, and Utilities. The main content area is titled 'System Information' and shows 'Model: VIA'. It contains several sections:

- Firmware Version:** 2.5.0519.1032, with a 'Check For Update' button.
- LAN Mac Address:** 74:D4:35:78:B8:B9.
- System Date/Time and Uptime:** System Date/Time: 2019-08-28 10:00:25; System Uptime: 00h 06m.
- Disk Space:** Total Disk Size: 58.7 GB; Space Available: 19.3 GB.
- iOS Mirroring:** Mirroring: ON; Mirror Name: Collage; Max # of Mirrored iOS Devices: 4.
- Chrome [?]:** Mirroring: OFF.
- VIA Discovery Service [?]:** VIA Discovery Service: Failed.
- VSM Connectivity:** Connectivity to VSM: Failure.
- Auto Broadcast:** VIA Auto Broadcast: ON.

Figure 7: Embedded Web Pages Home > System Information Page



Click the tabs in the navigation pane on the left to display the VIA web pages.



Click the arrow in the upper right corner to select a different language for the web pages.



After changing a setting, click **Reset VIA Session** for changes to take effect.

For settings that display the Apply or Apply Settings button, click **Apply** or **Apply Settings** to save the changes and then click **Reset VIA Session** for changes to take effect.

Configuring VIA Gateway Settings

VIA Campus² enables you to configure settings that apply to the VIA Campus² unit such as power, time, file format and management settings:

- [Verifying System Settings](#) on page [14](#).
- [Configuring Date and Time Settings](#) on page [15](#).
- [Configuring Automatic Power Settings](#) on page [18](#).
- [Changing Saved Files Location](#) on page [19](#).
- [Defining Default Volume Level](#) on page [20](#).
- [Configuring Dual Displays](#) on page [20](#).

- [Configuring VIA Campus² to be Managed by VSM](#) on page [20](#).
- [Defining Advanced Settings](#) on page [22](#).

Verifying System Settings

VIA Campus² enables you to verify system settings such as firmware version, date, uptime, disk space, iOS Mirroring status, Chrome server connection status, Miracast[®] status, VSM connectivity, auto broadcast status and LAN parameters.

To verify system settings:

- Click **Home** > **System Information** on the navigation page.
The System Information page appears ([Figure 7](#)).

Configuring Date and Time Settings

VIA Campus² enables you to change the date format displayed on the embedded web pages (for example, on the System Information page), set the time zone for the VIA Campus² device and add an NTP server.

Changing Date Format

To change the date format for the embedded web pages:

1. Click **VIA Management > VIA Settings** on the navigation pane ([Figure 7](#)).
The VIA Settings page appears ([Figure 8](#)).

VIA Settings

<u>SYSTEM & IOS</u>	DISPLAY	POWER	DATE & TIME	ADVANCED	RECORDING & STREAMING
Do not start HDMI input on startup					<input type="checkbox"/>
Activate PIP Mode	<input type="button" value="Reset PIP Position"/>				<input type="checkbox"/>
Activate System Log					<input type="checkbox"/> ?
Activate Media Mode					<input type="checkbox"/> ?
Quick Client Access					<input type="checkbox"/> ?
Activate Energy Saver Mode					<input type="checkbox"/> ?
VIA Minimized Menu Icon on Gateway - Always on Top					<input checked="" type="checkbox"/> ?
Do Not Disturb					<input type="checkbox"/> ?
Third Party App Shortcut					<input type="checkbox"/> ?

iOS Mirroring

Mirroring ?

Mirror Name

Max # of Mirrored iOS Devices ?

Chrome Settings

Activate

Figure 8: VIA Management > VIA Settings > System & iOS Tab

2. Click **Date & Time**.

The Date & Time tab appears.

VIA Settings

SYSTEM & IOS DISPLAY POWER **DATE & TIME** ADVANCED RECORDING & STREAMING

Date and Time Format for Web interface

Date Time Format Y-m-d HH:MM:SS

VIA Gateway Timezone Configuration

Set Time Zone (UTC+01:00) Amsterdam, B ?

24 hours format

Figure 9: VIA Management > VIA Settings > Date & Time Tab

3. In the Date and Time Format for Web Interface section, select a format from the Date Time Format drop-down.
4. In the VIA Gateway Timezone Configuration section, select your time zone. The date format for the embedded web pages is changed.

Setting Time Zone

To set the time zone for VIA Campus²:

1. Click **VIA Management > VIA Settings** navigation pane ([Figure 7](#)). The VIA Settings page appears ([Figure 8](#)).
2. Click **Date & Time**. The Date & Time tab appears ([Figure 9](#)).
3. In the VIA Gateway Timezone Configuration section, select the required time zone from the Set Time Zone drop-down. The time zone for **VIA Campus²** is set.

Adding NTP Server

VIA Campus² enables you to add an NTP (Network Time Protocol) server to synchronize your VIA gateway time.

To add an NTP server:

1. Click **VIA Management > Global Settings** on the navigation pane ([Figure 7](#)).
The Global Settings page appears with the Session & Broadcast tab open.

Global Settings

Session & Broadcast Upload Certificate NTP

Session & Broadcast

Session Timeout 24 Hours

Captcha ON OFF

VIA Auto Broadcast Info ON OFF

Apply

Figure 10: VIA Management > Global Settings > Session & Broadcast Tab

2. Click **NTP**.
The NTP tab appears.

NTP Server Enter Server Name ? Save











NTP Server Name	Edit	Delete
time-a.nist.gov		
time-b.nist.gov		
time-nw.nist.gov		
time.nist.gov		
time.windows.com		

Figure 11: VIA Management > Global Settings > NTP Tab

3. In the Enter Server Name field, enter the address of the NTP server.
4. Click **Save**.
The new NTP server is saved and appears in the NTP Server table.



To edit an NTP server name, click the icon in the Edit column.

To delete an NTP server name, click the icon in the Delete column.

Configuring Automatic Power Settings

VIA Campus² enables you to configure automatic power settings for resetting your unit and saving on power usage.

Configuring Auto Reboot

VIA Campus² enables you to define a time of day that the unit automatically reboots.

To configure auto reboot:

1. Click **VIA Management** > **VIA Settings** on the on the navigation pane ([Figure 7](#)).
The VIA Settings page appears ([Figure 8](#)).
2. Click **Power**.
The Power tab appears.

Auto Power Off Timing

Activate ON OFF ?

Time of Day - Hours Minutes

Auto Reboot Timing

Activate ON OFF ?

Time of Day - Hours Minutes

Note: Applied changes will take effect once the VIA is rebooted or the VIA session is reset.

[Reset VIA Session](#)

Figure 12: VIA Management > VIA Settings > Power Tab

3. In the Auto Reboot Timing section, click **ON**.
4. Select the hours (24-hour format) and minutes for the time of day for the **VIA Campus²** to automatically reboot every day.
5. Click **Reset VIA Session** for settings to take effect.
Auto reboot is configured.

Configuring Auto Power Off

VIA Campus² enables you to define a time of day that the unit automatically powers off.

To configure auto power off:

1. Click **VIA Management** > **VIA Settings** on the navigation pane ([Figure 7](#)).
The VIA Settings page appears ([Figure 8](#)).

2. Click **Power**.
The Power tab appears ([Figure 12](#)).
3. In the Auto Power Off Timing, click **ON**.
4. Select the hours (24 hour format) and minutes for the time of day for the **VIA Campus²** to automatically shut off every day.
Auto power off is configured.

Activating Energy Saver Mode

Energy saver mode automatically sends your **VIA Campus²** unit into sleep mode after 1 minute of inactivity.

To activate energy saver mode:

1. Click **VIA Management > VIA Settings** on the navigation pane ([Figure 7](#)).
The VIA Settings page appears with the System & IOS tab open ([Figure 8](#)).
2. Select the **Activate Energy Saver Mode** checkbox.
Energy saver mode is activated.

Changing Saved Files Location

VIA Campus² enables you to change the location of the VIA Cloud directory. VIA Cloud is where all meeting files are saved so that they can be accessed by and shared among participants in a VIA meeting. The default location for VIA Cloud is the **VIA Campus²** internal storage.

To change the saved files location:

1. On the Gateway Dashboard Settings login window ([Figure 65](#)), select **General User** and click **OK**.

The Cloud Directory window appears.

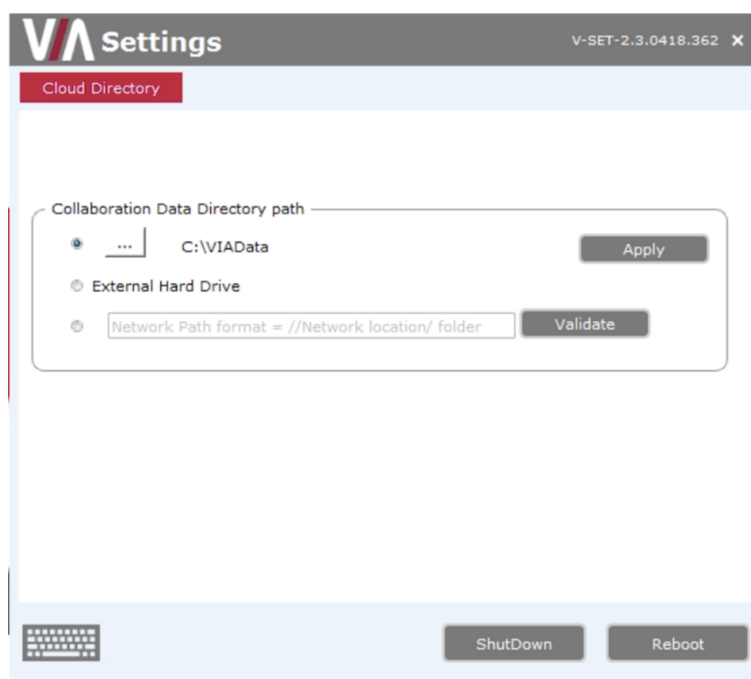

Figure 13: Cloud Directory Window

2. Do one of the following:
 - Click the browse button, select a new location from the browser window and click **Apply**.
 - Select **External Hard Drive**.
Files are saved to a USB storage device connected to the USB 3.0 Connectors ^① on the **VIA Campus²** front panel.
 - Select the last option, type a location on the network that the device is connected to and click **Validate** to test the location address.

The saved files location is changed.

Defining Default Volume Level

VIA Campus² enables you to set a default volume level for the VIA unit. After rebooting the unit, resetting a session, or all users logging off, the volume returns to the defined level.

To define the default volume level:

1. Click **VIA Management > VIA Settings** on the navigation pane ([Figure 7](#)).
The VIA Settings page appears ([Figure 8](#)).
2. Click **Advanced**.
The Advanced tab appears. ([Figure 15](#)).
3. In the Default Audio Level section, select the desired volume level.
The default volume level is defined.

Configuring Dual Displays

VIA Campus² enables you to connect two displays simultaneously. You can configure the displays as duplicates, to show the same content or you can use one as the main display and the other as an extension, to provide additional screen space.

To configure the behavior of dual displays:

1. On the Gateway Dashboard Settings Screen ([Figure 66](#)), click **System Controls**.
The System Controls tab appears.
2. Click **Display**.
The Screen Resolution window appears.
3. From the Multiple Displays drop-down, select **Duplicate these displays** or **Extend these displays**.
4. Click **OK**.
The displays restart with the selected configuration.

Configuring VIA Campus² to be Managed by VSM

VSM (VIA Site Management) is an optional, web-based software application (subject to a separate pricing) that enables an administrator to monitor and make changes to all VIA

gateways connected to the network. **VIA Campus²** enables you to activate VSM management for a VIA gateway and define which gateway functions are managed by VSM.



Contact your regional sales representative for more details about this solution.



If VIA discovery is enabled and configured in VSM, your VIA device is automatically added under VSM supervision.

To configure VIA Campus² to be managed by VSM when VIA discovery is not activated:

1. Click **VIA Management > VIA Site Management** on the navigation pane ([Figure 7](#)).

The VIA Site Management page appears.

VIA Site Management

Step 1: Server Settings

VIA Server IP ?

Gateway ID ?

?

Step 2: Configuration

All From VIA Site Management All From Gateway

<p>Wallpaper</p> <p><input type="radio"/> From VIA Site Management <input checked="" type="radio"/> From Gateway</p>	<p>Digital Signage</p> <p><input type="radio"/> From VIA Site Management <input checked="" type="radio"/> From Gateway</p>
<p>VIA Settings</p> <p><input type="radio"/> From VIA Site Management <input checked="" type="radio"/> From Gateway</p>	<p>Global Settings</p> <p><input type="radio"/> From VIA Site Management <input checked="" type="radio"/> From Gateway</p>
<p>Moderator Mode</p> <p><input type="radio"/> From VIA Site Management <input checked="" type="radio"/> From Gateway</p>	<p>Calendar Settings</p> <p><input type="radio"/> From VIA Site Management <input checked="" type="radio"/> From Gateway</p>
<p>Gateway Features</p> <p><input type="radio"/> From VIA Site Management <input checked="" type="radio"/> From Gateway</p>	
<p>Client Features</p> <p><input type="radio"/> From VIA Site Management <input checked="" type="radio"/> From Gateway</p>	
<p>Mobile Features</p> <p><input type="radio"/> From VIA Site Management <input checked="" type="radio"/> From Gateway</p>	

Note: This will take approximately 30 minutes - 1 hour to get all the settings from VSM.

Figure 14: VIA Management > VIA Site Management Page

2. In the Step 1: Server Settings section, enter the VSM Server IP.
3. Enter the Gateway ID that was defined in VSM for this gateway.
4. Click **Validate and Save**.
Changes take effect immediately.



VIA Campus² must be able to connect to VSM while validating is in progress.

-OR-

Click **Save** for changes to be saved with no validation from VSM.



Since validation is not made immediately, any error entered at this stage, like duplication of ID, must be corrected manually at a later stage.

5. In the Step 2: Configuration section, select **From VIA Site Management** for all functions to be managed by VSM.

-OR-

Select **All From VIA Site Management (VSM)** to manage all functions from VSM.



After clicking Apply and Reset, changes take 30 minutes to 1 hour to take effect, to allow time to communicate with VSM.

Defining Advanced Settings

VIA Campus² enables you to define advanced settings for your **VIA Campus²** gateway.

Defining Automatic End of Meeting Actions

VIA Campus² enables you to define what happens when all meeting participants have disconnected from **VIA Campus²**.

To define end of meeting actions:

1. Click **VIA Management > VIA Settings** on the navigation pane ([Figure 7](#)).
The VIA Settings page appears ([Figure 8](#)).
2. Click **Advanced**.

The Advanced tab appears.

VIA Settings

SYSTEM & IOS DISPLAY POWER DATE & TIME **ADVANCED** STREAMING

End of Meeting Settings—

When all participants have disconnected from VIA:

Clean the Cloud ?

Close Whiteboard and Auto Save

Close Whiteboard and Discard

Do not Close Whiteboard

File Sharing Settings—

All Files

Selected Files [\[Edit \]](#) ?

avi,bmp,dbt,divx,doc,docx,dot,ett,flv,gif,html,m4a,m4v,mht,mkv,mov,mp3,mp4,mpeg,mpg,ppt,pptx,prs,rm,rmv,rmvb,rtf,svg,tiff,txt,vob,wav,wma,wmv,wps,wpt,xls,xlt,xml

API Settings Command[?]—

Secure Non Secure

Reset Session[?]—

Activate

Default Encoding for Presentation[?]—

Auto/H264 JPEG

VIA Gateway Audio Output—

Audio Output ?

Default Audio Level—

Default Audio Level ?

Note: Applied changes will take effect once the VIA is rebooted or the VIA session is reset.

[Reset VIA Session](#)

Figure 15: VIA Management > VIA Settings > Advanced Tab

- In the End of Meeting Settings section, select the desired options for When all participants have disconnected from VIA:
 - Clean the Cloud** – delete all files from the VIA cloud (see [Managing VIA Cloud Files](#) on page 119).
 - Close Whiteboard and Auto Save** – Close the Whiteboard on the main display and save the current page to the VIA cloud.
 - Close Whiteboard and Discard** – Close the Whiteboard on the main display and discard the current page.
 - Do not Close the Whiteboard** – leave the Whiteboard open on the main display.

End of meeting actions are defined.

Setting Audio Output

VIA Campus² enables you to set whether the audio is output as digital audio to the HDMI output or as analog to the 3.5mm mini jack.

To set the audio output:

1. Click **VIA Management > VIA Settings** on the navigation pane ([Figure 7](#)).
The VIA Settings page appears ([Figure 8](#)).
2. Click **Advanced**.
The Advanced tab appears ([Figure 15](#)).
3. In the VIA Gateway Audio Output section, select the required audio output from the drop-down.
The audio output is set.

Defining File Sharing Formats

VIA Campus² enables you to define which types of files may be shared among participants during a meeting (see [Sharing Files](#) on page [118](#)).

To define the file sharing formats:

1. Click **VIA Management > VIA Settings** on the navigation pane ([Figure 7](#)).
The VIA Settings page appears ([Figure 8](#)).
2. Click **Advanced**.
The Advanced tab appears ([Figure 15](#)).
3. In the File Sharing Settings section, click **Selected Files**.
The file format selector window appears.
4. Under File Extension, select or clear file extensions as required.
5. Click **Apply**.
File format changes are applied.
6. Under Add Extension, enter a new file extension.
7. Click **Add**.
The new file extension is added to the File Extension list.

Defining API Security

To define API security settings:

1. Click **VIA Management > VIA Settings** on the navigation pane ([Figure 7](#)).
The VIA Settings page appears ([Figure 8](#)).
2. Click **Advanced**.
The Advanced tab appears. ([Figure 15](#)).

3. In the API Setting Command section, select one of the following:
 - **Secure** – API commands can be sent to the VIA gateway securely over a TLS port.
 - **Non-Secure** – API commands can be sent to the VIA gateway on a non-secure, plain text port. Select this option if your controller does not support TLS.

API security settings are defined.

Defining Default Encoding Format

VIA Campus² enables you to set a default encoding format for participant devices. This is the encoding format used when a participant presents and streams video from the Kramer VIA app.



For instructions on how a participant can change the encoding format for their own device during a meeting, see [Changing Encoding Format](#) on page [129](#).

To define the default gateway encoding format:

1. Click **VIA Management > VIA Settings** on the navigation pane ([Figure 7](#)).
The VIA Settings page appears ([Figure 8](#)).
2. Click **Advanced**.
The Advanced tab appears ([Figure 15](#)).
3. Under Default Encoding for Presentation, select **Auto/H264** or **JPEG**.
4. Click **Reset VIA Session**.
The default encoding format changes to the selected one.

Managing Network Settings

VIA Campus² enables you to change the IP address of your **VIA Campus²** unit and upload a custom SSL certificate:

- [Changing Device IP Address](#) on page [25](#).
- [Uploading SSL Certificate](#) on page [26](#).

Changing Device IP Address



The default IP setting is DHCP that assigns an automatic IP address to your unit. This enables easy plug and play setup when connecting your **VIA Campus²** to the network. The following explains how to change a static IP address.



When changing these settings, make sure they are correct. Incorrect values can cause a loss of communication.

To change the IP address of your VIA Campus² unit:

1. Click **VIA Management > Network Settings**.
The Network Settings page appears.

Network Settings

LAN Settings

IP Configuration

Static DHCP

Network Information	
Host Name	VIA-1C1B
Gateway IP	192.168.1.13
Subnet Mask	255.255.255.0
Default Gateway	192.168.1.1
DNS Server	192.168.1.1

Apply Settings

Mac Address Information	
LAN Mac Address	1C:1B:0D:88:14:8F

Reboot Shutdown

Figure 16: VIA Management > Network Settings Page

2. Under IP Configuration, select **Static**.
3. In the Network Information table, change the IP settings.
4. Click **Apply Settings**.
The IP address of your VIA Campus² unit is changed.

Uploading SSL Certificate

VIA Campus² enables you to upload a custom SSL certificate to better provide for the security needs of your organization.



To prevent damage to the system, make sure you upload files that can be used by the system. If you are unsure of how to use this feature, contact technical support.

For information on how to create a certificate, see [Creating an SSL Certificate for VIA](http://www.kramerav.com/product/VIA_Campus2), available at: [www.kramerav.com/product/VIA_Campus²](http://www.kramerav.com/product/VIA_Campus2)

After obtaining your certificate, install it on your VIA device.



The uploaded files must stay in the format of “server.crt” & “server.key”.

To upload an SSL certificate:

1. Click **VIA Management > Global Settings** on the navigation pane ([Figure 7](#)).
The Global Settings page appears ([Figure 10](#)).
2. Click **Upload Certificate**.
The Upload Certificate tab appears.

Global Settings

NTP Upload Certificate Session Settings

Figure 17: VIA Management > Global Settings – Upload Certificate Tab

3. Click **Browse File** for Web Server (Apache) Certificate.
A file browser appears.
4. Open the relevant certificate file and click **Upload**.
5. Click **Browse File** for Upload new key file.
A file browser appears.
6. Open the relevant key file click **Upload**.



Do not upload the key file until the certificate file is finished uploading.

7. Restart your device.
The SSL certificate upload is completed.

Managing User Access

VIA Campus² enables you to create new users and define their level of access to features and settings:

- [Creating New Users](#) on page 28.
- [Configuring Moderator Mode](#) on page 31.

Creating New Users

VIA Campus² enables you to create new users and define their level of access to system settings and whether or not they can become a moderator while participating in a meeting.

There are two default users available to log in to VIA Campus²:

- Super User – Web Administrator access to all features and settings; this user cannot be deleted. However, its password can be changed (recommended). It also can become a moderator:
 - Default user name: su
 - Default password: supass
- User – Limited access to settings; participant access to features and settings; cannot become a moderator:
 - Default user name: user
 - Default password: userpass

To create a new user:

1. Click **User Management > Add User** on the navigation pane ([Figure 7](#)). The Add User page appears.

Add User

Username ?

Password

Confirm Password

User Role Web Administrator Digital Signage [Note: To use this feature license should be available.]

Save

Figure 18: User Management > Add User Page

2. Type the new Username, Password and Confirm Password.
3. Under User Role, select from the following administrative levels:
 - **Web Administrator** – Access to change all system settings, including Digital Signage.

- **Digital Signage** – Able to configure the Digital Signage only (see [Configuring Digital Signage](#) on page 62).
4. Select one of the following participation levels:
- **Moderator** – User is able to become a moderator and has access to features such as [Streaming a Meeting Session](#) (see page 131).



Moderator Mode must be activated to enable becoming a Moderator during a meeting (see [Configuring Moderator Mode](#) on page 31).

- **Participant** – User participates in a meeting, but cannot access moderator features.
5. Click **Save**.
A new user is added and the User List tab appears with the new user added to the list.

User List

S. No.	Username	User Role	Edit	Delete
1	jimmy	Web Administrator		
2	moderator	ePolling,Digital Signage,Moderator		
3	participant	Participant		
4	si			
5	su	Web Administrator	-	-
6	susan	ePolling,Moderator		
7	user	Participant		

Figure 19: User List Page

Editing Users

VIA Campus² enables you to edit the password and permissions of users that are saved on your VIA Campus².

To edit a user:

1. Click **User Management > User List** on the navigation pane ([Figure 7](#)).
The User List page appears ([Figure 19](#)).

2. Click the icon in the Edit column for the relevant user.

The Edit User page appears.

Edit User

Username

Password

Confirm Password

User Role

- Web Administrator
- Digital Signage [Note: To use this feature license should be available.]

Figure 20: Edit User Page

3. Change the password and User Role definitions, as needed.

4. Click **Update**.

The changes are applied and the User List page appears.

Changing Your Password

VIA Campus² enables you to change your own password.

To change your own password:

1. Click **User Management > Change Password** on the navigation pane ([Figure 7](#)).
The Change Password page appears.

Change Password

Username

Old Password

New Password

Confirm New Password

Figure 21: Change Password Page

2. Click **Reset** to clear all the fields.

3. Type your Old Password, New Password, and Confirm Password.

4. Click **Update**.

The changes are applied and you are logged out of the embedded web pages.

Configuring Moderator Mode

VIA Campus² enables you to activate and configure Moderator Mode. You can define how users access Moderator Mode and enable some of the moderator features like disabling chat.

For more information about how a user becomes a moderator during a meeting, see [Becoming Meeting Moderator](#) on page [123](#).

To configure Moderator Mode:

1. Click **VIA Management > Moderator Mode** on the navigation pane ([Figure 7](#)). The Moderator Mode page appears.

Moderator Mode

Activate Moderator Mode

Moderator Mode

Database Based
 Active Directory
 Basic

Moderator can enable / disable Chat feature during a session ?

Allow Participant to confirm start of Presentation ?

Wait for Moderator to Start Session

Activate ePolling

Figure 22: VIA Management > Moderator Mode Page

2. Select the **Activate Moderator Mode** checkbox.
3. Select one of the Moderator Mode types:
 - **Basic** – Allows anyone to join a meeting without a username and password and to become moderator with a password defined by the Web Administrator.
 - **Databased** – Only users created by the Web Administrator (see [Creating New Users](#) on page [28](#)) can join a meeting.
 - **Active Directory** – See [Configuring Active Directory Moderator Mode](#) on page [33](#).
4. If you selected Basic, type a password and click **Apply**.

5. If required, select one or more of the following checkboxes:
- **Moderator can enable/disable Chat feature during a session** – See [Chatting with Participants](#) on page [117](#).
 - **Allow Participants to confirm start of Presentation** – See [Showing Participant Screen on Main Display](#) on page [124](#).
 - **Wait for Moderator to Start Session** – VIA session does not start until a moderator joins the meeting. Participant dashboard features are grayed out and a message appears on the main display.



This feature is not available in Basic Moderator Mode.

Thank you for joining. The session will begin once a Moderator connects to VIA.

A red rectangular box with rounded corners containing white text. The text is centered and reads: "Thank you for joining. The session will begin once a Moderator connects to VIA."

Figure 23: Main Display Message Before a Moderator Joins the Meeting

6. If you selected Active Directory, see [Configuring Active Directory Moderator Mode](#) on page [33](#).
Moderator Mode is configured.

Configuring Active Directory Moderator Mode

Groups grant access to resources. Organizational units (OUs) control objects and delegate group policy settings. **VIA Campus²** seamlessly integrates with Active directories (ADs) to avoid the hassle of creating users from **VIA Campus²**'s Web UI.

VIA Campus² Gateway contains the following groups that must be mapped with Active Directory groups or organizational units:

- **Moderator:** A user with meeting moderator rights i. e. this user can directly display his screen on a **VIA Campus²** Gateway and can allow a participant requesting for presentation on the main display.
- **Participant:** A participant in a presentation session who can join the meeting space, but cannot project their desktop without the moderator's permission.

Active directory must have groups or OUs like the above Moderator-Participant hierarchy. Do not use groups which have any employee in common.

If there is no such group or OU, create them in such a way that an employee is not in the moderator and the participant group at the same time.

To configure Active Directory Moderator Mode:

1. Click **VIA Management > Moderator Mode** on the navigation pane ([Figure 7](#)). The Moderator Mode page appears ([Figure 22](#)).



All participant devices must be governed through this Active Directory or they cannot log in.

2. Click **Activate Moderator Mode**.
3. Click **Active Directory** under **Moderator Mode**. The Active Directory options appear.

Moderator Mode

Activate Moderator Mode

Moderator Mode

Database Based
 Active Directory
 Basic

Moderator can enable / disable Chat feature during a session ?

Allow Participant to confirm start of Presentation ?

Active Directory Settings

Active Directory Domain

Group Based
 OU Based

VIA Group/OU Active Directory Group/OU

Moderator

Participant

Figure 24: VIA Management > Moderator Mode Page with Active Directory Options

4. Under **Active Directory Settings**, type in the Active Directory name in **Active Directory Domain** text box.
5. Select the **Group Based** or **OU Based** radio button as per your Active Directory configuration.
6. Based on the above selection, type the name of Moderator and Participant Group/OU in their respective boxes.

Active Directory Moderator Mode is configured.



VIA Campus² does not discover and connect to the Active Directory; rather it relies on you to correctly enter the details. If there is a typographical error in any of fields, the users (Moderators and Participants) cannot log in.

For further details, refer to “VIA Integration into DNS and Microsoft Active Directory” white paper.

Defining Web Pages Timeout

VIA Campus² enables you to define how long the timeout period is for the embedded web pages. One minute before the timeout period is over, a warning message appears, giving the user the option of extending the session before it ends.

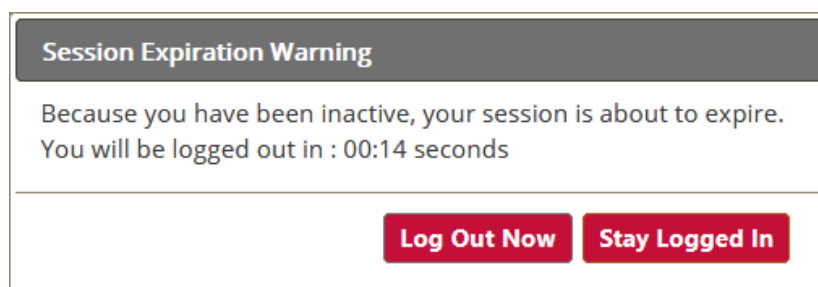

Figure 25: Embedded Web Pages Session Expiration (Timeout) Warning

To define the web page timeout period:

1. Click **VIA Management > Global Settings** on the navigation pane ([Figure 7](#)). The Global Settings page appears with the Session & Broadcast tab open ([Figure 10](#)).
2. Under Session Timeout, select the desired timeout period.

Web page timeout period is defined.

Disabling Captcha Text

VIA Campus² enables you to disable the Captcha text that is required when logging into the embedded web pages ([Figure 6](#)).

To disable the Captcha text:

1. Click **VIA Management > Global Settings** on the navigation pane ([Figure 7](#)). The Global Settings page appears with the NTP tab open ([Figure 10](#)).
2. Click **Session & Broadcast**. The Session & Broadcast tab appears ([Figure 10](#)).

3. Under Captcha, click **OFF**.
The Captcha text is disabled.

Managing VIA Features

VIA Campus² enables you to manage VIA features:

- [Rearranging Features Menu](#) on page [36](#).
- [Configuring VIA Pad Settings](#) on page [38](#).
- [Configuring iOS Mirroring Settings](#) on page [39](#).
- [Enabling Chrome Support](#) on page [40](#).
- [Activating Do Not Disturb Mirroring Feature](#) on page [40](#).
- [Configuring Display Controller](#) on page [43](#).

Rearranging Features Menu

VIA Campus² enables you to rearrange the position of features in the menu and hide features from the menu. Each of the following web pages enables managing a different features menu:

- Gateway Features – Menu available on the main display
- Client Features – Menu available on meeting participant laptops and tablets
- Mobile Features – Menu available on meeting participant smartphones

To rearrange the gateway, client or mobile feature menu:

1. Click **VIA Management > Gateway /Client /Mobile Features** on the navigation pane ([Figure 7](#)).

The selected Features page appears.

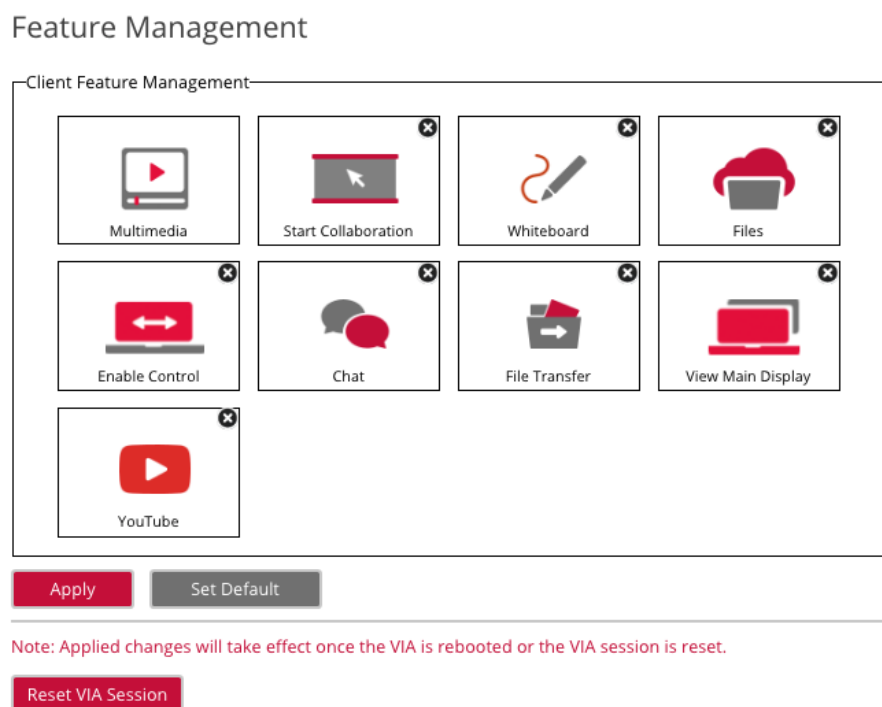

Figure 26: VIA Management > Client Features Page

2. Click and drag a feature icon.
The icon docks in the new position.

- 3. Click x on the upper right corner of the feature icon. The feature is hidden.

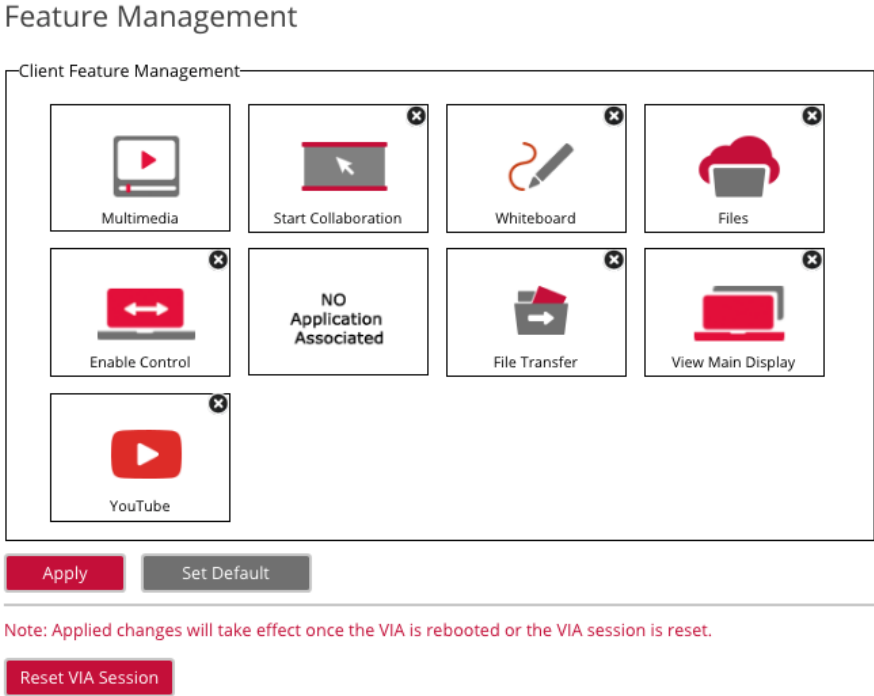

Figure 27: VIA Management > Client Features Page with Hidden Feature



To show a feature that was hidden, click **Set Default**.

Using VIA Pad

VIA Pad is an optional touch-pad accessory that enables meeting participants to instantly join a VIA meeting with their Mac or PC laptop:

- [Configuring VIA Pad Settings](#) on page [38](#).
- [Pairing a VIA Pad Device](#) on page [39](#).

Configuring VIA Pad Settings

VIA Campus² enables you to configure **VIA Pad** settings that define how a **VIA Pad** device operates when paired with your **VIA Campus²** unit.

To configure **VIA Pad** settings:

1. Click **VIA Management > VIAPad Configuration** on the navigation pane ([Figure 7](#)). The VIAPad Configuration page appears.

VIAPad Configuration

VIAPad Configuration	
Guest	<input type="checkbox"/> ?
VIAPad will override Room Code	<input checked="" type="checkbox"/> ?
Room Name	192.168.1.168

Wifi Configuration	
Auto Connect to WiFi	<input checked="" type="checkbox"/> ?
SSID	<input type="text"/> ?
Authentication Mode	Select <input type="text"/> ?
Encryption	Select <input type="text"/> ?
Key	<input type="text"/> <input type="checkbox"/> ?

Apply Settings

Figure 28: VIA Management > VIAPad Configuration Page

2. In the VIAPad Configuration section, select the following as required:
 - **Guest** – Participant can Present by touching the VIA Pad device; the **Kramer VIA** app dashboard is not available.
 - **VIA Pad overrides Room Code** – Participant can join a meeting without entering the room code.



Room Name is automatically populated; it reflects the name of your **VIA Campus²** unit.

3. In the Wifi Configuration section, select the **Auto Connect to Wi-Fi** checkbox, to configure **VIA Pad** to automatically connect to the meeting space Wi-Fi network. The auto connect parameters appear.
4. Define the following for the meeting space Wi-Fi network:
 - a. SSID – Name of the network



Make sure that you write it EXACTLY as defined. This parameter is case sensitive.

- b. Authentication Mode – Security used by your Wi-Fi access point. Select from the pre-set options: **WEP Open**, **WEP Shared**, **WPA Personal**, **WPA2 Personal**.
- c. Encryption – Type of encryption key used by your router.
- d. Key – Password required to join your network (up to 50 characters max).

VIA Pad settings are configured.



After clicking Apply Settings, the configuration is saved, there is no need to reboot your unit.

Pairing a VIA Pad Device

Each **VIA Pad** device must be paired to your **VIA Campus²** unit before being used by a meeting participant.

To pair a **VIA Pad** device to your **VIA Campus²** unit:

- Follow the directions below:

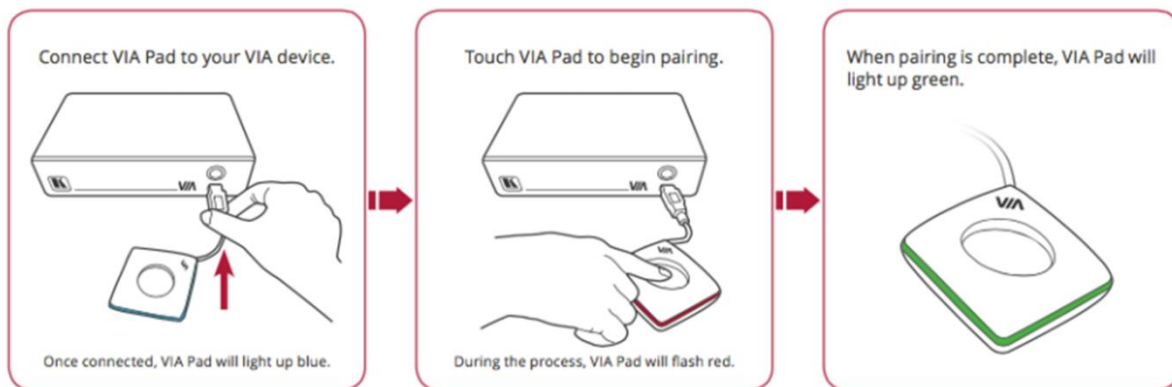

Configuring iOS Mirroring Settings

VIA Campus² enables you to configure iOS mirroring settings for using AirPlay to present on the main display.

To configure iOS mirroring settings:

1. Click **VIA Management > VIA Settings** on the navigation pane ([Figure 7](#)). The VIA Settings page appears with the System & IOS tab open ([Figure 8](#)).
2. In the iOS Mirroring section, click **ON** for Mirroring.
3. If desired, type a new Mirror Name. This is the name that appears when you look for AirPlay devices on your iOS device.

4. Select the maximum number of mirrored iOS devices that can be used simultaneously. iOS mirroring settings are configured.

Enabling Auto Broadcast

VIA Campus² can broadcast a signal to all **Kramer VIA** client applications connected to the same network (same VLAN). When a user starts to join a meeting, all VIA gateways that are broadcasting, automatically appear on the user's meeting room list (see [Joining a VIA Meeting Manually](#) on page 87).

To enable Auto Broadcast:

1. Click **VIA Management > Global Settings** on the navigation pane ([Figure 7](#)).
The Global Settings page appears with the Session & Broadcast tab open ([Figure 10](#)).
2. Under VIA Auto Broadcast, click **ON**.
3. Click **Apply**.
Auto Broadcast is enabled.



For information on how Auto Broadcast is enabled and what are its limitations, refer to the VIA IT Deployment Guide, available for download at: [www.kramerav.com/downloads/VIA Campus²](http://www.kramerav.com/downloads/VIA_Campus2).

Enabling Chrome Support

VIA Campus² enables you to activate support for Chrome browser and ChromeBook.

To enable Chrome support:

1. Click **VIA Management > VIA Settings** on the navigation pane ([Figure 7](#)).
The VIA Settings page appears with the System & IOS tab open ([Figure 8](#)).
2. In the Chrome Settings section, click **ON**.
Chrome support is activated after rebooting the unit.

Activating Do Not Disturb Mirroring Feature

VIA Campus² enables you to activate the Do Not Disturb mirroring feature that enables any participant that is using **Kramer VIA** app to mirror on the main display to prevent other participants from mirroring (see [Mirroring Without Being Interrupted](#) on page 97).

To activate the Do Not Disturb mirroring feature:

1. Click **VIA Management > VIA Settings** on the navigation pane ([Figure 7](#)).
The VIA Settings page appears with the System & IOS tab open ([Figure 8](#)).
2. Select the **Do Not Disturb** checkbox.
Do Not Disturb is enabled after the next reboot.

Activating Recording Feature

VIA Campus² enables you to record all activity on the main display during the course of a meeting (see [Recording a Meeting](#) on page 130). Before using the recording feature, you must activate it in the embedded web pages.

To activate the recording feature:

1. In the VIA Management > VIA Settings tab, click **Recording & Streaming**.
The **Recording & Streaming** tab appears.

Recording [?]

Activate ON OFF

System Default USB Cloud VSM

Streaming [?]

Streaming URL

Activate ON OFF

Note: To change the Streaming URL the service must first be stopped. Then the URL can be changed and Streaming can be turned on again.

Figure 29: VIA Settings > Recording & Streaming Tab

2. Under Activate, click **ON**.
3. In the Recording area, select one of the following locations to save the meeting recordings:
 - **System Default** – Default location on the VIA hard drive. Recordings are retrieved from the **Recording > Recording List** page.
 - **USB** – External drive connected to the USB connector on the **VIA Campus²**.
 - **Cloud** – VIA Cloud, see [Sharing Files](#) on page 118
 - **VSM** – Recordings are saved to the VIA hard drive and automatically transferred to the VSM server
4. Click **Reboot**.
The recording feature is activated.

Managing Meeting Recordings

VIA Campus² enables you to search, download and edit meeting recordings.

To manage meeting recordings:

1. Click **Recording > Recording List** on the left tabs of the VIA web pages.

The Recording List tab appears.

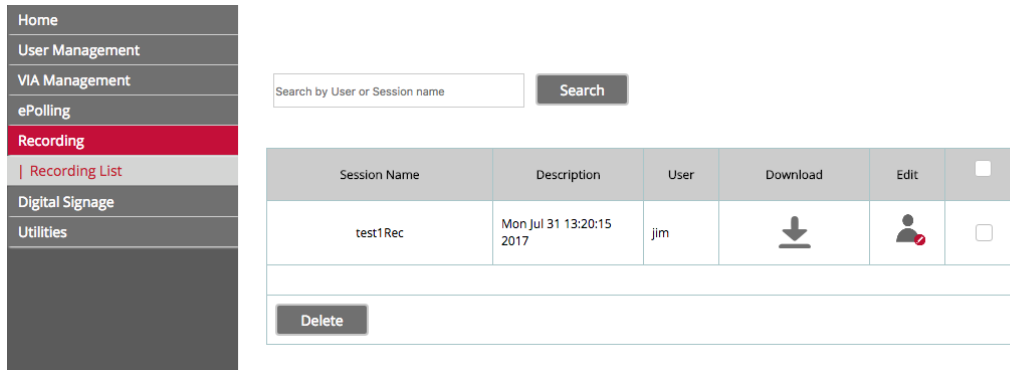

Figure 30: Recording List Tab

2. Perform any of the following:

- Type a User or Session name into the text box and click **Search**. Search results appear in the table below the Search text box.
- Click the icon in the Download column. The relevant recording is downloaded.
- Edit the recording file information:
 - a. Click the icon in the Edit column. The Edit Recording screen for the relevant recording appears.

Edit Recording:

Session Name:

Description:

Figure 31: Edit Recording Screen

- b. Edit the Session Name and the Description and click **Update**. The recording file information is updated.
- On the Recording List table ([Figure 30](#)), select a checkbox in the last column and click **Delete**. The selected recording is permanently deleted.

Enabling/Disabling User Session Reset Option

VIA Campus² enables you to enable or disable the Session Reset option that appears in the user taskbar menu. (Figure 99). The Session Reset feature enables you to reset the VIA session without rebooting VIA Campus².

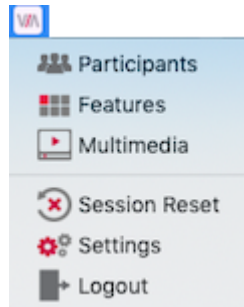

Figure 32: Kramer VIA Taskbar Menu with Session Reset Feature Enabled



By default, this feature does not appear in the user taskbar menu.

When Moderator Mode is activated (see [Configuring Moderator Mode](#) on page 31), this feature is available only to the moderator.

To enable or disable the user Reset VIA Session option:

1. Click **VIA Management > VIA Settings** on the navigation pane ([Figure 7](#)).
The VIA Settings page appears ([Figure 8](#)).
2. Click **Advanced**.
The Advanced tab appears. ([Figure 15](#)).
3. In the Reset Session section, click **ON** to enable and **OFF** to disable.
The user Reset VIA Session option is enabled/disabled.

Configuring Display Controller

VIA Campus² enables you to control a display screen that is connected to the same network as your VIA Campus².

This feature enables you to configure one of the following actions:

- When the first person joins the meeting, the main display powers ON and when the last person logs out of the meeting, the main display powers OFF.
- Send a switch HDMI Input command, to toggle between the VIA input and any other device connected to the same display.

To configure your VIA Campus² as a display controller:

1. Connect the display to be controlled to the same network as your **VIA Campus²**.
2. Click **VIA Management > Display Controller** on the navigation pane ([Figure 7](#)).

The Display Controller tab appears.

Display Controller

Figure 33: VIA Settings > Display Settings > Display Controller

3. Select the **Activate Control** checkbox.
4. Enter the Display IP address and Control IP Port of the display screen to be controlled.
5. For Source 1, enter the command to send when someone first joins a meeting (for example, power ON the display).
6. For Source 2, enter the command you want the VIA to send when the last participant logs out of the meeting (for example, power OFF display).
7. Select **ASCII** or **HEX** to define command format accepted by your display.



Refer to the User Manual for your display for the correct format of the commands.

Configuring your **VIA Campus²** as a display controller is complete.

Configuring Room Schedule on Main Display

VIA Campus² enables you to display scheduled meeting information on the main display home screen. VIA automatically retrieves information about meetings scheduled in the room where the VIA device resides. This feature is available for a room that has been added in Office 365[®] Admin Center, Microsoft Exchange[®] or in Google[®] Admin Console for G Suite[®].



Before configuring this feature in the VIA embedded web pages, you must add the room in either Office 365 Admin Center, Microsoft Exchange or Google Admin Console for G Suite. See [Configuring Third Party Apps for VIA Calendar Integration](#) available for download at: [www.kramerav.com/downloads/VIA_Campus²](http://www.kramerav.com/downloads/VIA_Campus2).

Configuring Room Schedule for Office 365 Calendar

To configure the room schedule for Office 365 Calendar:

1. Click **VIA Management > Calendar** on the navigation pane ([Figure 7](#)).
The Calendar page appears.

Figure 34: VIA Management > Calendar Page with Office 365 Calendar Selected

2. Select the **Activate Calendar** checkbox.
3. Under Account, select **Office 365 Basic Auth** from the Calendar Type drop down.
4. Enter the following for the room where this VIA gateway resides:
 - Username – Email address assigned to the room.
 - Password – Password associated with the room Username.
5. Select one of the following permission types for the user: **None, Impersonation, Delegate**.
6. Enter the email address for the resource calendar.
7. Click **Test Connection** to test if the details entered are correct.
8. Click **Save**.
The calendar is synced with VIA Calendar.

Configuring Room Schedule for Microsoft Exchange

When a resource mailbox (e.g. a meeting space) is created, the Exchange® administrator can synchronize with the mailbox to be none, an Impersonation or a Delegate.

To configure the room schedule for Microsoft Exchange:

1. Click **VIA Management > Calendar** on the navigation pane ([Figure 7](#)).
The Calendar page appears ([Figure 34](#)).
2. Select the **Activate Calendar** checkbox.
3. Select **MS Exchange** from the Calendar Type drop down.
The Microsoft Exchange controls appear.

Calendar

Activate Calendar ?

Note : Please configure the calendar account below.

ACCOUNT

Calendar Type MS Exchange

Exchange Server URL

Exchange Version Select

Username

Password 

Permission Type None ?

Resource Calendar

Save
Test Connection

Note: Applied changes will take effect once the VIA is rebooted or the VIA session is reset.

Figure 35:

4. Enter the server URL.
5. Select the relevant version of Microsoft Exchange.
6. Enter the following for the meeting space where this VIA gateway resides:
 - Username – Email address assigned to the meeting space.
 - Password – Password associated with the meeting space Username.
7. Select one of the following permission types for the user: **None**, **Impersonation**, **Delegate**.
8. In Resource Calendar, enter a calendar name to identify the created calendar.



This field is enabled only after Impersonation or Delegate is selected for permission type.

8. Click **Test Connection** to test if the details entered are correct.

9. Click **Save**.
The calendar is synced with VIA Calendar.

Configuring Room Schedule for Google Calendar

To configure the room schedule for Google Calendar:

1. Click **VIA Management > Calendar** on the navigation pane ([Figure 7](#)).
The Calendar page appears ([Figure 34](#)).
2. Select the **Activate Calendar** checkbox.
3. Select **Google** from the Calendar Type drop down.
The Google Calendar controls appear.

The screenshot shows the 'Calendar' configuration page. At the top, there is a section 'Activate Calendar' with a checked checkbox and a question mark icon. Below this is a red note: 'Note : Please configure the calendar account below.' Underneath is a section titled 'ACCOUNT' with a red underline. The 'Calendar Type' is set to 'Google' in a dropdown menu. Below this are three steps: 'Step 1' with a link 'Click here to get code', 'Step 2' with a text input field containing 'Please enter the code' and a 'Get Calendar' button, and 'Step 3' with a dropdown menu containing 'Select the calendar' and an 'Associate' button. At the bottom, there is a red note: 'Note: Applied changes will take effect once the VIA is rebooted or the VIA session is reset.' and a red 'Reset VIA Session' button.

Figure 36: VIA Management > Calendar Page with Google Calendar Selected

4. Click **Click here to get code**.
Google sign in page appears.
5. Sign-in with the Google account where the shared space calendar was created.
6. Allow access to VIA-Calendar.
An integration code appears.
7. Copy the integration code from the Google sign in page and paste it into the Step 2 field on the VIA Calendar page.
8. Click **Get Calendar**.
9. Under Step 3, select the calendar associated with the room.

10. Click **Associate**.

The room username appears on the Calendar page.

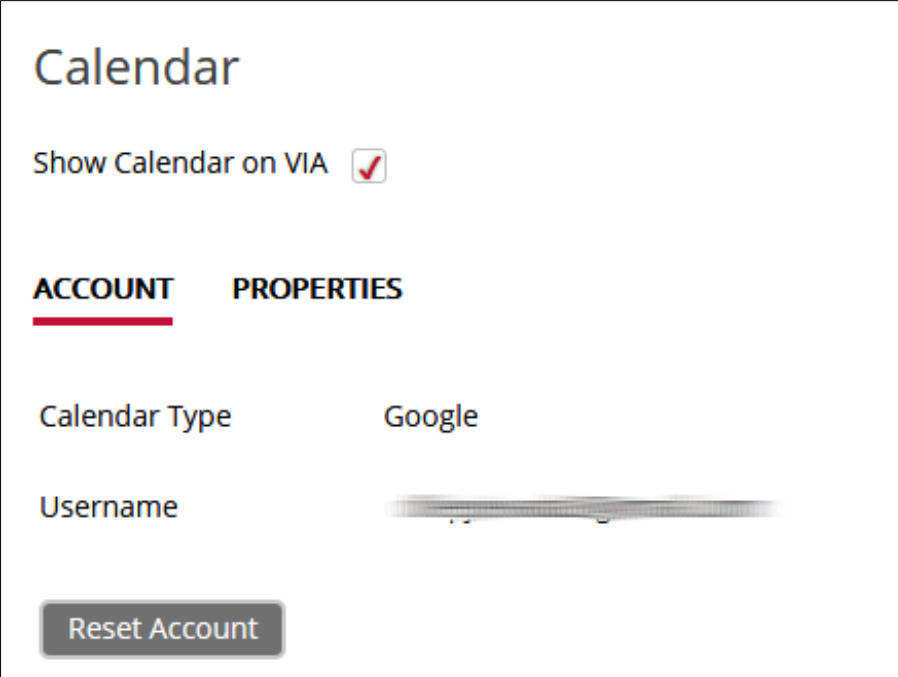

Calendar

Show Calendar on VIA

ACCOUNT **PROPERTIES**

Calendar Type Google

Username [blurred]

Reset Account

Figure 37: Calendar Page with Google Username



Click **Reset Account** to disassociate the calendar account.

Customizing Main Display Look and Feel

VIA Campus² enables you to customize the look and feel of the main display home screen:

- [Creating New Screen Layout](#) on page [49](#).
- [Formatting Screen Layout Widgets](#) on page [50](#).
- [Editing a Screen Layout](#) on page [55](#).
- [Deleting a Screen Layout](#) on page [55](#).
- [Export and Import a Screen Layout](#) on page [55](#).
- [Scaling Gateway Dashboard for Large Screens](#) on page [56](#).
- [Defining VIA Menu Icon Visibility on Main Display](#) on page [57](#).

Creating New Screen Layout

VIA Campus² enables you to custom design the screen layout for the main display. You can incorporate your company branding, display custom text, date & time and meeting login information. Create and save several versions of the screen layout and load them when needed.

To create a new screen layout for the main display:

1. Click **VIA Management > VIA Screen Editor** on the navigation pane ([Figure 7](#)). The Screen Editor page appears.

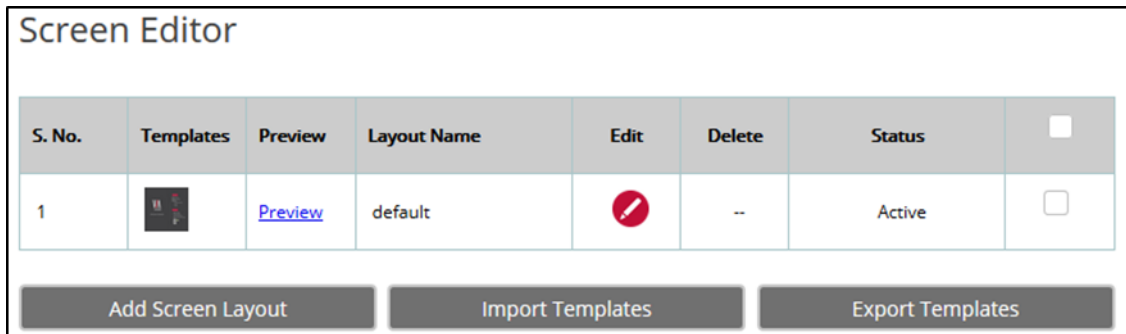

Figure 38: VIA Management > Screen Editor Page

2. Click **Add Screen Layout**.

The wallpaper upload window appears.

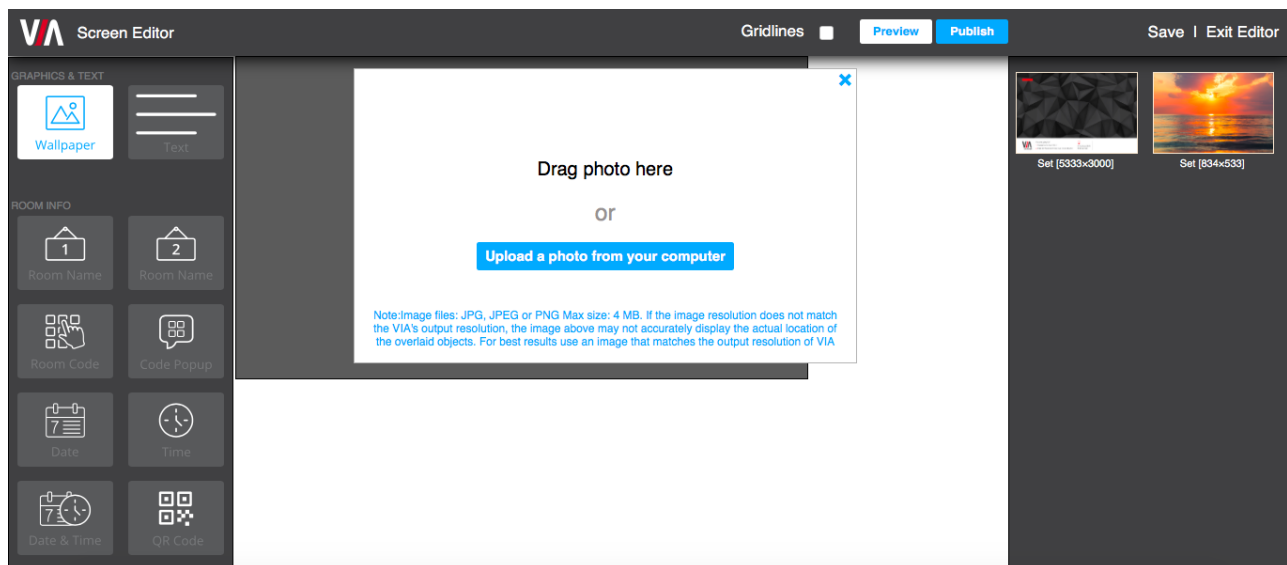

Figure 39: Wallpaper Upload Window

3. Drag an image file to the window or click **Upload a photo from your computer** and select an image file from your computer.



Wallpaper image files must be jpeg, png, or bmp format and a maximum size of 2 MB.

If the wallpaper image resolution does not match VIA's output resolution, the screen layout elements may not appear in the same location as they do in the Screen Editor. For best results, use a wallpaper image that matches the output resolution of VIA.

The Screen Editor window appears with the selected image in the work area.

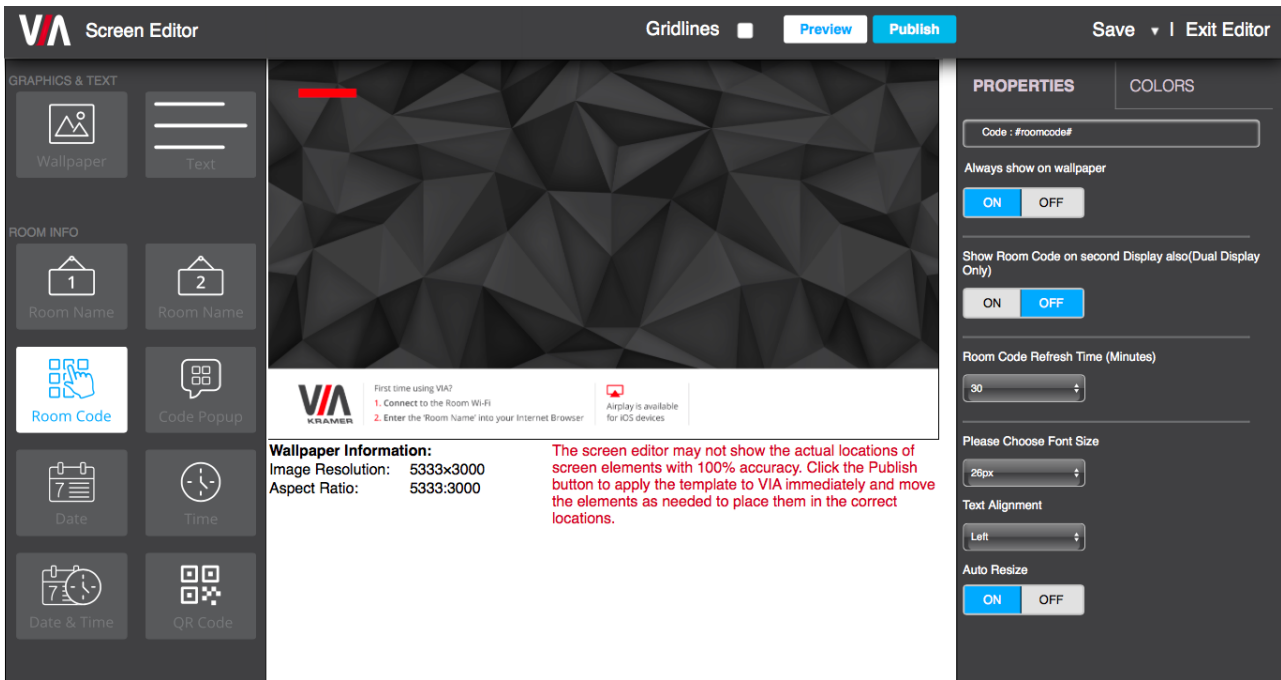



Figure 40: Screen Editor Window

4. Drag one of the following widgets (screen elements) from the left side of the window into the workspace in the middle:
The widget appears on the screen layout preview and the property controls appear on the right of the preview.
5. Format the widget with the property controls on the right side of the window (see [Formatting Screen Layout Widgets](#) on page 50).
6. Click and drag the widgets according to your preferred screen layout.

 Select the **Gridlines** checkbox to show a grid overlay that helps position elements on the layout.

 To remove a widget from the screen layout, click the X in the upper right corner of the widget.

7. Click **Save**.
The new layout is saved and will appear in the table of layouts on the Screen Editor page.
8. Click **Publish**.
The new screen layout appears on the main display.

Formatting Screen Layout Widgets

VIA Campus² provides different formatting options for each of the screen layout widgets (elements). You can define the position, color, format (for date and time) and refresh time (for Room Code) of these elements. In addition, you can display a customized DNS (Domain Name System) name instead of the default room name, if local DNS services are supported by the network and a DNS server is defined (see [Changing LAN Settings](#) on page 77).

Formatting Text

Format the following on the Properties tab:

- Enter the text in the text field.
- Select the font size and text alignment.
- Under Auto Resize, click **ON** to automatically resize the box to fit the size of the text. When the layout is published, on the main display the box size adjusts to fit the size of the text.

Format the following on the Color tab:

- Click the Background color box and select a fill color for the text box.
- Select the opacity of the text box.
- Click the Font Color box and select a font color.
- Under Border, click **ON**, click the Border Color box and select a border color.

Formatting Room Name 1

Room Name 1 is the address used join a meeting.

Format the following on the Properties tab:

- In the Room Name field, you can enter one or both of the following:
 - #roomname# – Automatically displays the IP address of the meeting space (default).
 - #airplayname# – Automatically displays the airplay name of the meeting space, (see [Mirroring Apple Laptops and iPhones Using iOS/OS X Airplay Service](#) on page 94).
- In the Custom Room Name field, enter a custom name for the meeting space. This name appears in place of the meeting space IP address when #roomname# is used in the Room Name field (see bullet above).



If you enter a name in the Custom Room Name, it does not change the IP address, but adds a custom name that can make it easier to identify the meeting space. This name appears in the meeting space list along with the IP address. A participant can start typing the custom name instead of the IP address to join the meeting (see [Joining a VIA Meeting](#) on page 86).



Custom room names only work if DNS has been configured to properly redirect the Room Name to the appropriate IP address or if broadcast is working in your network environment. We recommend adding a text field and including the VIA's IP address on the wallpaper as well as the custom name.

- Under Show Room Name on second Display also, click **ON** to show the room name on both displays, when using dual displays (see [Connecting Main Display](#) on page 9).

- Under Room Name Overlay:
 - Click **ON** to always show the room name on top of all content being presented on the screen.
 - Select the number of seconds the room name overlay is visible on top of participant content.
- Select the font size and text alignment.
- Under Auto Resize, click **ON** to automatically resize the box to fit the size of the text. When the layout is published, on the main display the box size adjusts to fit the size of the text.

For formatting on the Color tab, see [Formatting Text](#) on page 51.

Formatting Room Name 2

Room Name 2 shows the IP address for a second network, when in use (see [Enabling a Second Network](#) on page 78). You cannot create a custom name for this room name. For an explanation of formatting this widget, see [Formatting Room Name 1](#) on page 51.

Formatting Room Code

Room Code is the four digit code that participants need to join the meeting.

Format the following on the Properties tab:

- Under Always show on wallpaper, click **ON** to always show the room code on the main display background. The code will be hidden if there is content covering it.
- Under Show Room Code on second Display also, click **ON** to show the room code on both displays, when using dual displays (see [Connecting Main Display](#) on page 9).
- Under Room Code Refresh Time, select the time, in minutes, for how long a room code remains before changing to a different code.
- Select the font size and text alignment.
- Under Auto Resize, click **ON** to automatically resize the box to fit the size of the text. When the layout is published, on the main display the box size adjusts to fit the size of the text.

For formatting on the Color tab, see [Formatting Text](#) on page 51.

Formatting Code Popup

Code Popup shows the Room Code only when a participant enters the Room Name on **Kramer VIA** app to join the meeting. This popup appears on top of any content being presented on the main display.

Format the following on the Properties tab:

- Select the font size and text alignment.

For formatting on the Color tab, see [Formatting Text](#) on page 51.

Formatting Date

The Date widget displays the date according to the time zone settings of the VIA device (see [Setting Time Zone](#) on page [16](#)).

Format the following on the Properties tab:

- Select one of the following date formats:
 - **DD MON, YYYY** – Day Month, Year (for example: 1 January, 2019).
 - **MON DD, YYYY** – Month Day, Year (for example: January 1, 2019).
 - **DD MON** – Day Month (for example: 1 January).
 - **MON DD** – Month Day (for example: January 1).
- Select the font size and text alignment.
- Under Auto Resize, click **ON** to automatically resize the box to fit the size of the text. When the layout is published, on the main display the box size adjusts to fit the size of the text.

For formatting on the Color tab, see [Formatting Text](#) on page [51](#).

Formatting Time

The Time widget displays the time according to the time zone settings of the VIA device (see [Setting Time Zone](#) on page [16](#)).

Format the following on the Properties tab:

- Select **24 hour** or **AM/PM** time format.
- Select the font size and text alignment.
- Under Auto Resize, click **ON** to automatically resize the box to fit the size of the text. When the layout is published, on the main display the box size adjusts to fit the size of the text.

For formatting on the Color tab, see [Formatting Text](#) on page [51](#).

Formatting Date & Time

The Date & Time widget displays the date and time according to the time zone settings of the VIA device (see [Setting Time Zone](#) on page [16](#)).

Format the following on the Properties tab:

- Select **24 hour** or **AM/PM** time format.
- Select the font size and text alignment.
- Under Auto Resize, click **ON** to automatically resize the box to fit the size of the text. When the layout is published, on the main display the box size adjusts to fit the size of the text.

For formatting on the Color tab, see [Formatting Text](#) on page [51](#).

Formatting QR Code

The QR Code widget is a QR code that enables a participant to join the meeting by scanning the code with their device.

Format the following on the Properties tab:

- Under Enable QR code, click **ON** to enable joining the meeting using the QR code.
- Under Bypass room code, click **ON** to enable joining the meeting using the QR code without entering the room code.
- Under Keep QR code always on top, click **ON** to always show the QR code on top of all content being presented on the screen.



To print a hard copy of the QR code to post in the meeting space, go to VIA Management > VIA Settings > Display and click **Print QR Code**.

Formatting Calendar

The Calendar widget displays information about meetings scheduled in the room where the VIA device resides.



The VIA Calendar feature must be configured and activated to use this widget (see [Configuring Room Schedule on Main Display](#) on page 44)

Format the following on the Properties tab:

- Select **24 hour** or **AM/PM** time format.
- Under Show Title, click **ON/OFF** to show/hide the meeting title.
- Under Show Organizer, click **ON/OFF** to show/hide the name of the meeting organizer.
- Under No. of Records to display, select how many upcoming meetings to display
- Under Please choose font size, select the font size.

Format the following on the Color tab:

- Click the Background color box and select a fill color for the calendar.
- Select the opacity of the calendar.
- Click the Meeting Tile Font Color box and select a font color.
- Select a bar color for the following meeting statuses:
 - In Use.
 - Available.
 - Upcoming.

Formatting Timer

The Timer widget is a pop-up that displays a notification that counts down the last several minutes before the next meeting is scheduled to start in the room.

Format the following on the Properties tab:

- Under Please choose top and bottom text font size, select the font size for text appearing above and below the time.
- Under Please choose middle text font size, select the font size for the time.
- Under Meeting alert display, select the amount of time before the next meeting to display the notification and start the countdown.

For formatting on the Color tab, see [Formatting Text](#) on page [51](#).

Editing a Screen Layout

To edit a screen layout:

1. Click **VIA Management > VIA Screen Editor** on the navigation pane ([Figure 7](#)).
The Screen Editor page appears ([Figure 38](#)).
2. Click **Edit** in the row of the layout that you want to edit.
The Screen Editor window appears ([Figure 40](#)).
3. Edit the layout as desired (see [Creating New Screen Layout](#) on page [49](#)).
4. Click **Save**.
The screen layout edits are saved.

To save the edited screen layout as a new layout:

1. Click the arrow next to Save and select **Save As**.
The template name window appears.
2. Enter a new name for the layout and click **Submit**.
The edited layout is saved as a new layout.

Deleting a Screen Layout

To delete a screen layout:

1. Click **VIA Management > VIA Screen Editor** on the navigation pane ([Figure 7](#)).
The Screen Editor page appears ([Figure 38](#)).
2. Click **Delete** in the row of the layout that you want to delete.
A confirmation message appears.
3. Click **OK**.
The selected screen layout is deleted from the VIA device and removed from the list.

Export and Import a Screen Layout

VIA Campus² enables you to export a screen layout in the form of a .screen file to share and to use on other VIA devices.

To export a screen layout:

1. Click **VIA Management > VIA Screen Editor** on the navigation pane ([Figure 7](#)).
The Screen Editor page appears ([Figure 38](#)).
2. Select the checkbox at the end of the row of the layout that you want to delete and click **Export Templates**.
A confirmation message appears.
3. Click **OK**.
A screen layout file (.screen) is downloaded to your device.

To import a screen layout:

1. Click **VIA Management > VIA Screen Editor** on the navigation pane ([Figure 7](#)).
The Screen Editor page appears ([Figure 38](#)).
2. Click **Import Templates**.
A file browser window appears.
3. Select the desired screen layout file and click **Choose**.
The selected file is uploaded to **VIA Campus²** and the imported layout appears in the screen layout list.



Make sure that the exported layout file fits the resolution of the VIA device to which it is imported.

Scaling Gateway Dashboard for Large Screens

VIA Campus² enables you to enlarge the gateway dashboard on the main display when using a large, high resolution screen.

To scale the dashboard for large screens:

1. Click **VIA Management > VIA Settings** on the navigation pane ([Figure 7](#)).
The VIA Settings page appears ([Figure 8](#)).

2. Click **Display**.

The Display tab appears ([Figure 41](#)).

VIA Settings

SYSTEM & IOS **DISPLAY** POWER DATE & TIME ADVANCED RECORDING & STREAMING

Display Layout

Display Layout ?

Auto-Hide Thumbnails ?

Language

Select Language ?

VIA Gateway User Interface Scaling

User Interface Scaling ?

Figure 41: VIA Management > VIA Settings > Display Tab

3. In the VIA Gateway User Interface Scaling section, select **Large** from the **User Interface Scaling** option box.
4. Click **Reset VIA Session**.
The dashboard is scaled for large screens.

Defining VIA Menu Icon Visibility on Main Display

VIA Campus² enables you to define if participant content presented on the main display hides the VIA menu icon or if the VIA menu icon remains on top of participant content and visible.

To define VIA menu icon visibility on the main display:

1. Click **VIA Management > VIA Settings** on the navigation pane ([Figure 7](#)).
The VIA Settings page appears with the System & IOS tab open ([Figure 8](#)).
2. Select/clear the **VIA Minimized Icon on Gateway – Always On Top** checkbox.
VIA menu icon visibility on the main display is defined.

Maintaining Your VIA Unit

VIA Campus² enables you to maintain your VIA unit by performing the following:

- [Using Gateway Activity Log](#) on page [58](#).
- [Updating Firmware](#) on page [59](#).
- [Resetting Default Settings](#) on page [60](#).
- [Running Setup Wizard](#) on page [62](#).

Using Gateway Activity Log

VIA Campus² embedded web pages provide a log of gateway activities such as logins, presentation and VIA features usage to aid in diagnosing a problem or tracking participant usage.

Activating Gateway Activity Log

To activate the gateway activity log:

1. Click **VIA Management > VIA Settings** on the navigation pane ([Figure 7](#)).
The VIA Settings page appears with the System & IOS tab open ([Figure 8](#)).
2. Select the **Activate System Log** check box.
The gateway activity log is activated.

Searching Gateway Activity Log

To search the gateway activity log:

1. Click **Utilities > Webadmin Activity Log** on the navigation pane ([Figure 7](#)).
The Webadmin Activity Log page appears.

Webadmin Activity Log

Start Date

End Date

Username

Action Taken

Total number of log entries found: 7

User Id	Action Taken	Activity Date	Remarks	Host Name
su	Login	12-09-2018 09:15 AM	Success	10.0.1.5
su	Login	12-09-2018 09:15 AM	Failure	10.0.1.5
su	Login	12-09-2018 09:15 AM	Success	10.0.1.5
su	Login	12-09-2018 11:03 AM	Success	10.0.1.5
su	Login	12-09-2018 13:30 PM	Success	10.0.1.5
su	Login	12-09-2018 15:06 PM	Success	10.0.1.5
su	Login	12-09-2018 16:06 PM	Success	10.0.1.5

Figure 42: Utilities – Webadmin Activity Log

2. Select the Start Date and the End Date to define the date range of log entries to be displayed.
3. Click the Username drop-down to filter log entries according to a particular user.

4. Click the Action Taken drop-down to filter log entries according to actions such as login, logout or activate.
5. Click **Search**.
The filtered search results appear in the table at the bottom of the page.



Click **Export to PDF** or **Export to CSV** to save a file of the log table on your computer.

Updating Firmware

VIA Campus² enables you to update your VIA Campus² firmware.



The upload process and then the unit reboot may take a few minutes.

To update your VIA Campus² firmware:

1. Click **Utilities > Update Firmware** on the navigation pane ([Figure 7](#)).
The Update Firmware page appears.

Update Firmware

Firmware Package

Upload new firmware package:

Current Version : 2.4.1018.996 [[Details](#)] [Release Notes](#)

OS Type : FC 23

Hardware Type : 3010

Current Date : 24-12-2018

Figure 43: Utilities > Update Firmware Page

2. When using an update file saved on your computer:
 - a. Click **Browse File**.
A file browser appears.
 - b. Select the relevant firmware update file.
 - c. Click **Upload**.
The new firmware is uploaded to the unit and the firmware is updated.

When using an update file on the website, and you have an internet connection:

- a. Click **Check for Update**.
A message appears with information about an available update.



Check for Updates is also available on the System Information Page ([Figure 7](#)).

- b. If an update is available, confirm the download.
The new firmware is downloaded to your computer.
- c. Click **Browse File**.
A file browser appears.

d. Select the relevant firmware update file.

e. Click **Upload**.

The new firmware is uploaded to the unit, the FW is updated and the unit reboots.



To verify the update, view the current firmware version on the upper right corner of the dashboard Participants tab.

Resetting Default Settings

VIA Campus² enables you to reset VIA Campus² to factory defaults.



Resetting Digital Signage removes the DSS license from the unit.

Resetting Calendar Settings removes the calendar settings from the unit and credentials will be required to renew synchronization to your calendar.

To reset default settings:

1. Click **Utilities > Maintenance** on the navigation pane ([Figure 7](#)).
The Maintenance page appears.

Maintenance

Reset

- Select All
- Reset VIA Settings
- Reset Wallpaper
- Reset Users
- Reset Moderator Mode
- Reset Gateway Features
- Reset Client Features
- Reset Mobile Features
- Reset VIAPad Configuration
- Reset Digital Signage
- Reset Global Settings
- Show Setup wizard on next reboot
- Reset Calendar Settings

Reset Logs

- Reset Logs

Figure 44: Maintenance Page

2. Select the default configurations you would like to reset or click **Select All** to select all settings.
3. Click **Apply**.
Selected settings are reset.

Running Setup Wizard

VIA Campus² enables you to run the Setup Wizard on the next reboot of the VIA Campus² unit.

To run the setup wizard:

1. Click **Utilities > Maintenance** on the navigation pane ([Figure 7](#)).
The Maintenance page appears ([Figure 44](#)).
2. Select the **Show setup wizard on next reboot** checkbox.
3. Click **Apply**.
The setup wizard runs on the next reboot.

Configuring Digital Signage

VIA Campus² enables you to configure digital signage. The Digital Signage feature enables you to use VIA Campus² to display dynamic content and information on the main display when there is no meeting in progress. Use a predefined template or create your own display configuration with up to three frames of content that appear simultaneously. Then, schedule campaigns (contact configurations) to run automatically at specific dates and times.

Configuring digital signage includes the following steps:

- [Creating and Uploading Digital Signage Media](#) on page [62](#).
- [Adding Fonts to Digital Signage](#) on page [68](#).
- [Adding Digital Signage Templates](#) on page [69](#).
- [Configuring a Digital Signage Campaign](#) on page [71](#).
- [Managing Digital Signage License](#) on page [74](#).

Creating and Uploading Digital Signage Media

VIA Campus² enables you to create a library of media content to be displayed through the digital signage feature. The types of media that can be displayed are:

- URL – Live web page.
- Scrolling Text – Custom text message that scroll across the screen.
- Image – Static image (allowed file extensions: jpg, jpeg, bmp, gif, png).
- Video (allowed file extensions: avi, mpeg, wmv, mpg, mov, vob, mkv, mp4, m4v).
- RSS feed –Live RSS feed.





To create and upload digital signage media:

1. Click **Digital Signage > Manage Content** on the navigation pane ([Figure 7](#)).

The Upload Media File page appears.

Upload Media File

Create Web Url
Create Scroller
Create RSS
Upload Media [?]

Existing Media	Edit	<input type="checkbox"/>	Preview
CNN_Int_RSS.rss		<input type="checkbox"/>	Preview
Demo_1.vsf		<input type="checkbox"/>	Preview
kingdom of colours.mp4		<input type="checkbox"/>	Download
Kramer Website.vurl		<input type="checkbox"/>	Preview
Moroko Loko.mp4		<input type="checkbox"/>	Download
VIA Website.vurl		<input type="checkbox"/>	Preview
welcome.vsf		<input type="checkbox"/>	Preview

Delete

Figure 45: Digital Signage > Upload Media File Page

2. Create and upload media, as required:

- [Adding Web URL](#) on page [64](#).
- [Creating Scrolling Text](#) on page [65](#).
- [Uploading Media Files](#) on page [66](#).
- [Adding RSS Feed](#) on page [67](#).

Adding Web URL

Add the URL of an existing web page or use a third-party solution (for example, Google Slides) to publish a presentation to the web and add the URL of the presentation.

To add a web url for digital signage:

1. On the Upload Media File page ([Figure 45](#)), click **Create Web URL**.
The Create URL window appears.



The screenshot shows a 'Create Url' dialog box. It has a title bar 'Create Url'. Inside, there are three input fields: 'URL' containing 'http://www.', 'File Name' containing 'NewUrlFile', and 'Auto Refresh' with an unchecked checkbox. At the bottom, there are two buttons: 'Save' and 'Exit'.

Figure 46: Digital Signage – Create URL Window

2. Type the URL address and File Name and click **Save**.
The new URL is added to the Existing Media list.
3. Select the **Auto Refresh** checkbox to display a URL with dynamic content
OR
Clear the **Auto Refresh** checkbox to display a URL as a static page.

Creating Scrolling Text

To create scrolling text:

1. On the Upload Media File page ([Figure 45](#)), click **Create Scroller**.

The Scroll Text Editor window appears.

Figure 47: Digital Signage Scroll Text Editor Window

2. Type the text to be displayed in the box at the top of the window.
3. Type a name for the scroller in the File Name text box.
4. In the Options area of the window, select the scrolling speed and click **Font Color/Background Color** to pick the text and background color.

 Select **Zero** for speed to create a static text display that does not scroll.

5. Click **Preview**.
A preview of the scroller appears at the top of the window.
6. Click **Save**.
The new Scroller is added to the Existing Media list.

 The following variables can be entered into the text field:

- #airplayname# – Displays the airplay name.
- #roomname# – Displays the room name/code for joining into the meeting.
- #apass# – Displays the Access Point password.
- #apname# – Displays the Access Point name.
- #ipaddress1# – Displays the IP address for the primary network.
- #ipaddress2# – Displays the IP address for the second network, if in use.

Uploading Media Files

To upload media files:

1. On the Upload Media File page ([Figure 45](#)), click **Upload Media**.
A file browser window appears.

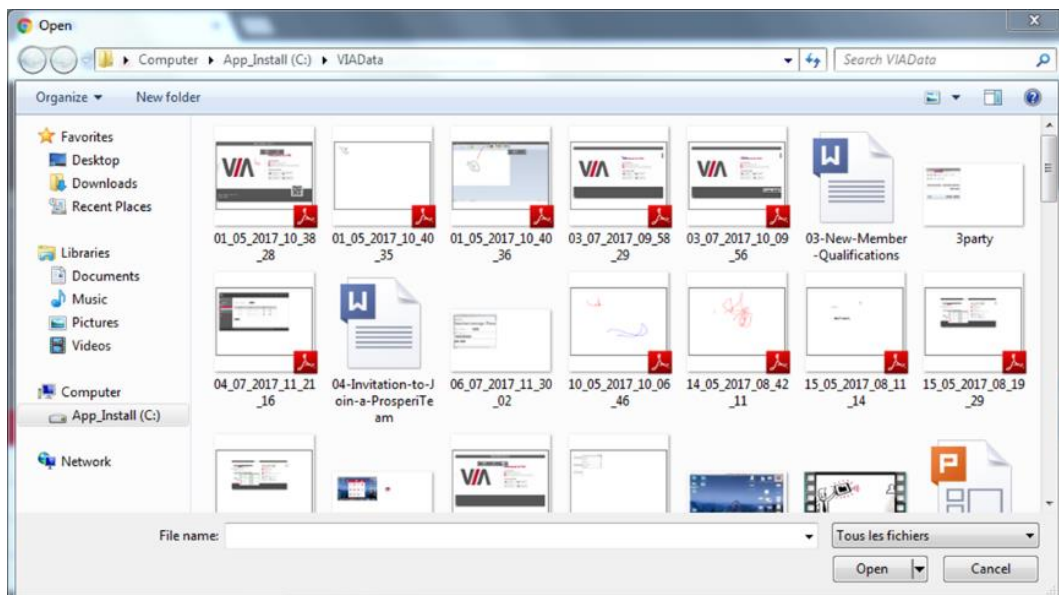

Figure 48: Digital Signage Upload Media File Browser

2. Select an image or video file and click **Open**.
The file is added to the Existing Media list.

Adding RSS Feed

To add an RSS feed:

1. On the Upload Media File page ([Figure 45](#)), click **Create RSS**.
The RSS Text Editor window appears.

Figure 49: Digital Signage RSS Text Editor Window

2. Under RSS URL, enter the RSS feed URL address.
3. Click **Get tags**.
The Select a tag drop-down list appears.
4. Select the required tag from the drop-down list.
5. Under File Name, enter the name that will appear on the Existing Media list.
6. Click **Preview** to view a preview of the RSS feed.
7. Under options, select the speed, display style, font, font color and background color for the RSS feed.
8. Click **Save**.
The new RSS feed is added to the Existing Media list ([Figure 45](#)).

Adding Fonts to Digital Signage

To add new fonts to Digital Signage:

1. Click **Digital Signage > DSS Management** on the navigation pane ([Figure 7](#)).
The DSS Management page appears.

DSS Management

License Management **Font Management**

Digital Signage License File

Upload License File

Figure 50: Digital Signage > DSS Management Page – License Tab

2. Click **Font Management**.
The Font Management tab appears.

DSS Management

License Management **Font Management**

Font Management

Upload Font ?

S. No.	Font Name	Delete
1	Arial	-
2	Calibri	-
3	Cambria	-
4	Century	-
5	Comic Sans MS	-
6	Courier New	-
7	Impact	-
8	Sylfaen	-
9	Tahoma	-

Figure 51: Digital Signage > DSS Management Page – Font Management Tab

3. Click **Browse File**.
A file browser appears.
4. Open the relevant font file and click **Upload**.
The new font is installed on **VIA Campus²** and can be used for Digital Signage.



Adding Digital Signage Templates

VIA Campus² enables you to preview, edit, delete and add digital signage templates.

To add a digital signage template:

1. Select **Digital Signage > Template Manager** on the navigation pane ([Figure 7](#)).
The Template Manager page appears.

Template Manager

Screen Template Name [?]	Edit	Delete
Standard Dynamic		
Classic Dynamic		
Even Dynamic		
Standard		
Classic		
Even		
Template1		

Add Template

Figure 52: Digital Signage > Template Manager Page

2. Click the name of a template.
A window opens, showing a preview of the selected template.

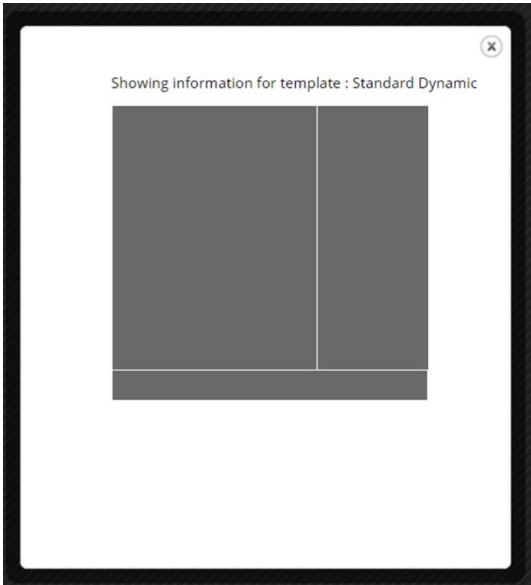

Figure 53: Digital Signage Template Preview Window

3. Click **Add Template**.

The template builder screen appears.

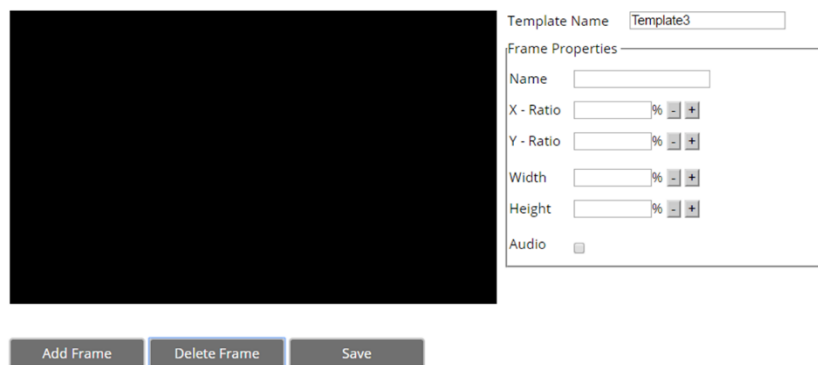

Figure 54: Digital Signage Template Builder Screen

4. Type a name for the new template in the Template Name text box.

5. Click **Add Frame**.

A new frame appears in the black preview box.

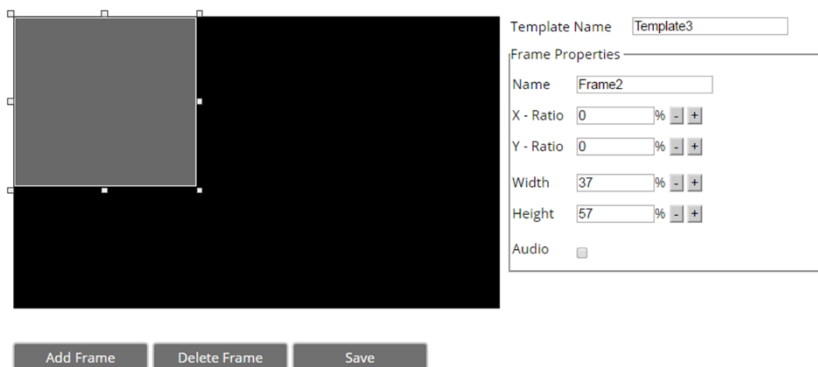

Figure 55: Digital Signage Template Builder Screen – New Frame

6. Type a name for the frame in the Frame Properties area.

7. Click and drag the box to move and resize it.

8. Type a name for the frame in the Frame Properties area.

9. Select the **Audio** checkbox to play audio from the selected frame.

10. Repeat steps 5–9 to add up to two more frames.



When two frames overlap, the one created last appears on top.

11. Click **Save**.

The new template is added and appears in the Template Manager list.



Click **Edit** to open the template builder screen and edit the selected template.



Click **Delete** to delete the selected template.

Configuring a Digital Signage Campaign

The Schedule Playlist tab enables defining:

- What is displayed in each frame of a digital signage display.
- When a digital signage display appears.

To define a digital signage campaign:

1. On the left side of the embedded web pages, select **Digital Signage > Schedule Playlist**.

The Schedule Playlist page appears.

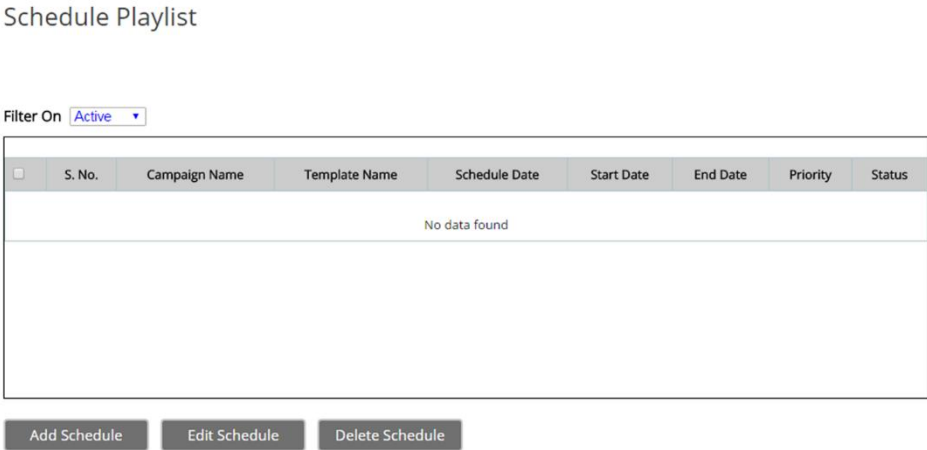

Figure 56: Digital Signage > Schedule Playlist Page

2. Click **Add Schedule**.

The WHEN To Play tab appears.

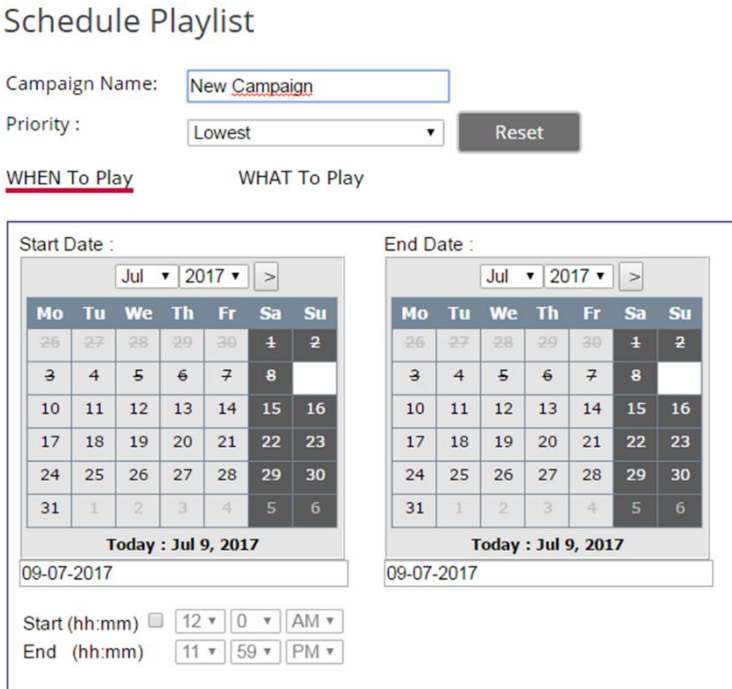

Figure 57: Digital Signage > Schedule Playlist > WHEN to Play Tab

3. Enter a Campaign Name.

- 4. Select a Priority level for the Campaign.
When two Campaign schedules overlap, VIA plays the one with the higher priority level.
- 5. Select a Start Date on the first calendar and an End Date on the second calendar.
- 6. Select the checkbox next to Start (hh:mm) to define a start time for the first day of the campaign and an end time for the last day of the campaign.
- 7. Click **WHAT to Play**.

The WHAT to Play tab appears.

Schedule Playlist

Campaign Name:

Priority :

WHEN To Play WHAT To Play

Media

Media Type :

<input type="checkbox"/>	Media Name	Media Type	Media Group
<input type="checkbox"/>	Kramer website.vurl	vurl	Web
<input type="checkbox"/>	Apple.vurl	vurl	Web
<input type="checkbox"/>	IT Message.vsf	vsf	Scroller
<input type="checkbox"/>	Moroko Loko.mp4	mp4	Video
<input type="checkbox"/>	Google.vurl	vurl	Web
<input type="checkbox"/>	1562_WORDS_Kramer3_Cloud_Chat.mp4	mp4	Video

Template View
Template :

Schedule Detail(s)

<input type="checkbox"/>	Frame	Media	Play Length
No data found.			

Figure 58: Digital Signage > Schedule Playlist WHAT to Play Tab

8. In the Template View section on the right side, select a template.

A preview of the selected template appears in the Template View section.

Schedule Playlist

Campaign Name:

Priority:

WHEN To Play WHAT To Play

Media

Media Type:

<input type="checkbox"/>	Media Name	Media Type	Media Gro
<input type="checkbox"/>	Kramer website.vurl	vurl	Web
<input type="checkbox"/>	Apple.vurl	vurl	Web
<input type="checkbox"/>	IT Message.vsf	vsf	Scroller
<input type="checkbox"/>	Moroko Loko.mp4	mp4	Video
<input type="checkbox"/>	Google.vurl	vurl	Web
<input type="checkbox"/>	1562_WORDS_Kramer3_Cloud_Chat.mp4	mp4	Video

Schedule Detail(s)

<input type="checkbox"/>	Frame	Media	Play Length
<input type="checkbox"/>	Main Frame	Kramer website.vurl	60
<input type="checkbox"/>	Side Frame	Moroko Loko.mp4	
<input type="checkbox"/>	Scroller Frame	IT Message.vsf	

Template View

Template:

Scroller Frame

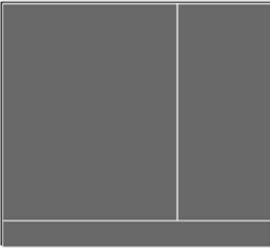
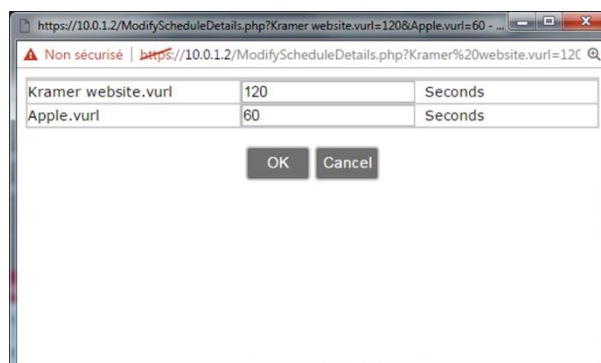

Figure 59: WHAT to Play Tab

9. Click one of the frames in the template preview, select one or more media objects from the media section and click **Add to Playlist**.

All selected media for the selected frame appears in the Schedule Details area.

10. Click the **Advanced** button to set the running time for a web page (URL).



Media Name	Play Length	Unit
Kramer website.vurl	120	Seconds
Apple.vurl	60	Seconds

Figure 60: Set Running Time for Web page

11. Click **Save**.

The new campaign is saved, and it appears on the Schedule Playlist page.

Schedule Playlist

Filter On Active ▾

<input type="checkbox"/>	S. No.	Campaign Name	Template Name	Schedule Date	Start Date	End Date	Priority	Status
<input type="checkbox"/>	2	First Campaign	Standard Dynamic	09/07/2017	12/07/2017	14/07/2017	5	Scheduled

Figure 61: Scheduled Campaign displayed in the Schedule Playlist Page



To delete a campaign, select the relevant campaign and click **Delete Schedule**.

Managing Digital Signage License

Installing First Digital Signage License



Port 443 must be enabled before activating a Digital Signage license. The license is downloaded from <https://discovery.wowvision.com> via this port.

To activate your first Digital Signage license:

1. Select **Digital Signage > DSS Management** on the navigation pane ([Figure 7](#)).

The DSS Management page appears with the License Management tab open.

DSS Management

License Management

No active DSS License found. Please consider purchasing a permanent license.

Digital Signage License File

Figure 62: Digital Signage > DSS Management Page

2. Click **Activate License**.

The license is installed on **VIA Campus²** and license information appears at the bottom of the page.

License Management **Font Management**

Digital Signage License File

Upload License File

License File Name :

Licensed : 16-04-2019

Current Date : 29-01-2019

Figure 63: Digital Signage License Information

For Web Administrator: Configuring Settings – Gateway Dashboard

VIA Campus² enables users with Web Administrator access to configure LAN settings and access system controls.

Logging in to Gateway Dashboard Settings

The gateway dashboard Settings can be accessed by connecting a mouse and keyboard directly to the VIA gateway unit (see [For Installer: Connecting VIA Campus²](#) on page 8) or through an external device that is logged in to the meeting and in Collaboration mode (see [Collaborating on Main Display](#) on page 99).

To log in to the Gateway Dashboard Settings:

1. Click the VIA icon in the upper right of the main display ([Figure 77](#)).
The gateway dashboard appears.



Figure 64: VIA Campus² Gateway Dashboard

2. Click **Features > Settings**.
The login window appears.

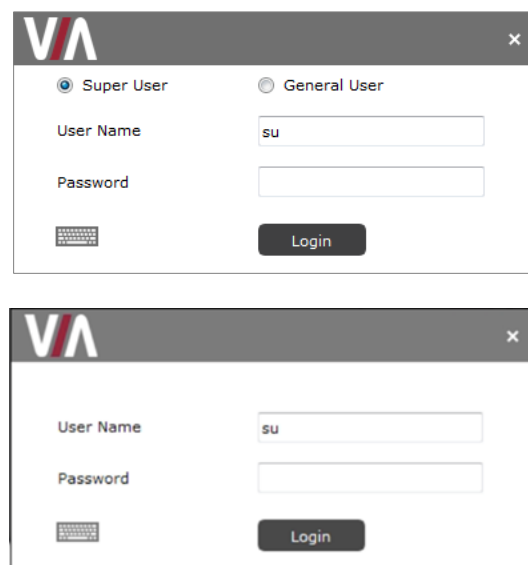

Figure 65: Settings Login Window

3. Type an administrator user name and password (default user name = su, default password = supass).

The Settings screen appears with the LAN Settings tab open.

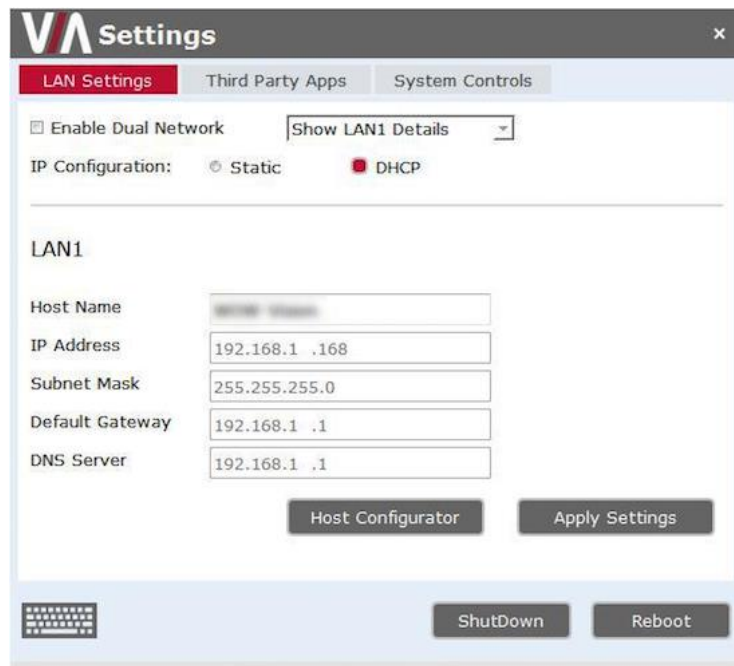

Figure 66: Gateway Dashboard – Settings Screen

Changing LAN Settings

VIA Campus² enables you to change the IP address, DNS server and default gateway of your VIA Campus² unit.



The default IP setting is DHCP that assigns an automatic IP address to your unit. This enables easy Plug and Play setup when connecting your VIA Campus² to the network. The following explains how to change a static IP address.



When changing these settings, make sure they are correct. Incorrect values can cause a loss of communication.

To change the LAN settings:

1. On the Gateway Dashboard Settings Screen ([Figure 66](#)), under IP Configuration, select **Static**.
2. Enter, as required, the Host Name, IP Address, Subnet Mask, Default Gateway, DNS Server.
3. Click **Apply Settings**.
4. Click **OK** in the Confirmation Message.
The system reboots with the new settings.

Enabling a Second Network

VIA Campus² enables you to connect to the device using two separate networks. For details about how to properly configure this feature, refer to VIA Multiple Network Installation Guide, available at:

[www.kramerav.com/product/VIA_Campus²](http://www.kramerav.com/product/VIA_Campus2).

To enable a second network:

- On the Gateway Dashboard Settings Screen ([Figure 66](#)), select the **Enable Dual Network** checkbox.



To view and/or change LAN settings for the second network, select **Show LAN2 Details** from the dropdown.



If you do not require a second network, make sure to disable the dual network feature and deactivate or unplug the unneeded RJ-45 cable to avoid unwanted communication from this socket.

Accessing System Controls

VIA Campus² enables you to access VIA Campus² operating system controls such as the control panel, audio settings, display settings, task manager, system health. You can also view log files and activate your VIA Campus² unit.



The log folder is only available if system logging is activated (see [Using Gateway Activity Log](#) on page [58](#)).



The VIA Campus² unit is pre-activated by Kramer. In case your license has been revoked, you can activate it here.

To access system controls:

1. On the Gateway Dashboard Settings Screen ([Figure 66](#)), click **System Controls**.

The System Controls tab appears.



Figure 67: System Control Screen

2. Click the required icon.

For User: Running Kramer VIA App

Kramer VIA app enables you to use VIA Campus² for collaborative meetings. Before moderating or joining a meeting, run the Kramer VIA app on your device using one of the following methods:

- [Running Kramer VIA App for PC and Mac](#) on page [80](#).
- [Running Kramer VIA App for Tablets & Smartphones](#) on page [80](#).
- [Running Kramer VIA App for Chromebooks/Chrome Web Browser](#) on page [81](#).
- [Running Kramer VIA App Using an Installation File](#) on page [85](#).



Participants using an Apple device can mirror their screen on the main display using the Apple AirPlay service without running the Kramer VIA app (see [Mirroring Apple Laptops and iPhones Using iOS/OS X Airplay Service](#) on page [94](#)).

Running Kramer VIA App for PC and Mac

To run Kramer VIA, for PC and Mac computers:

1. Open your Web browser and enter the IP address for your VIA Campus² unit. Your Web browser recognizes your operating system (MAC/Windows) and directs you to the correct client software. The embedded web pages Welcome page appears ([Figure 5](#)).
2. Click one of the following two options:
 - **Run VIA** – runs Kramer VIA virtually, without installing it on your computer. Once downloaded, locate the file on your computer (under “Downloads”) and click it to launch. The VIA Campus² join screen appears.
 - **Install VIA** – installs Kramer VIA on your computer. After the .exe file is downloaded to your computer, a confirmation message appears. Click **Yes** and follow the Setup Wizard instructions. The Kramer VIA app is saved to the KRAMER folder on your C:/ProgramFiles directory drive by default and a desktop shortcut is created for easy access. However, you can select a different target folder in the Setup Wizard.

Running Kramer VIA App for Tablets & Smartphones

To run Kramer VIA for tablets and smartphones:

- Download Kramer VIA app from the App Store (iOS) or Google Play (Android).

Running Kramer VIA App for Chromebooks/Chrome Web Browser

You can run **Kramer VIA** app directly from your Chromebook or Chrome web browser by adding a Chrome extension (see [Installing VIA Screen Share Extension](#) on page [81](#)), without downloading the app to your device. Join the meeting while sitting in the meeting room using this method (see [Running Kramer VIA App Using Chromebooks/Chrome](#) on page [83](#)) or, if **VIA Campus²** has an active internet connection, join remotely, from any location with the help of a participant in the meeting room (see [Joining a Meeting Remotely Using Chromebooks/Chrome](#) on page [84](#)).

 Chrome support must be activated by a Web Administrator to use this feature, see [Enabling Chrome Support](#) on page [40](#)).

Installing VIA Screen Share Extension

To run **Kramer VIA** for Chromebooks/Chrome web browser, you must first install the VIA Screen Share extension, available in the Chrome Web Store.

 If you have already installed the VIA Screen Share extension, go to [Running Kramer VIA App Using Chromebooks/Chrome](#) on page [83](#).

To install the VIA Screen Share extension:

1. Navigate to the **VIA Campus²** IP address with your browser.
The VIA Welcome page appears.

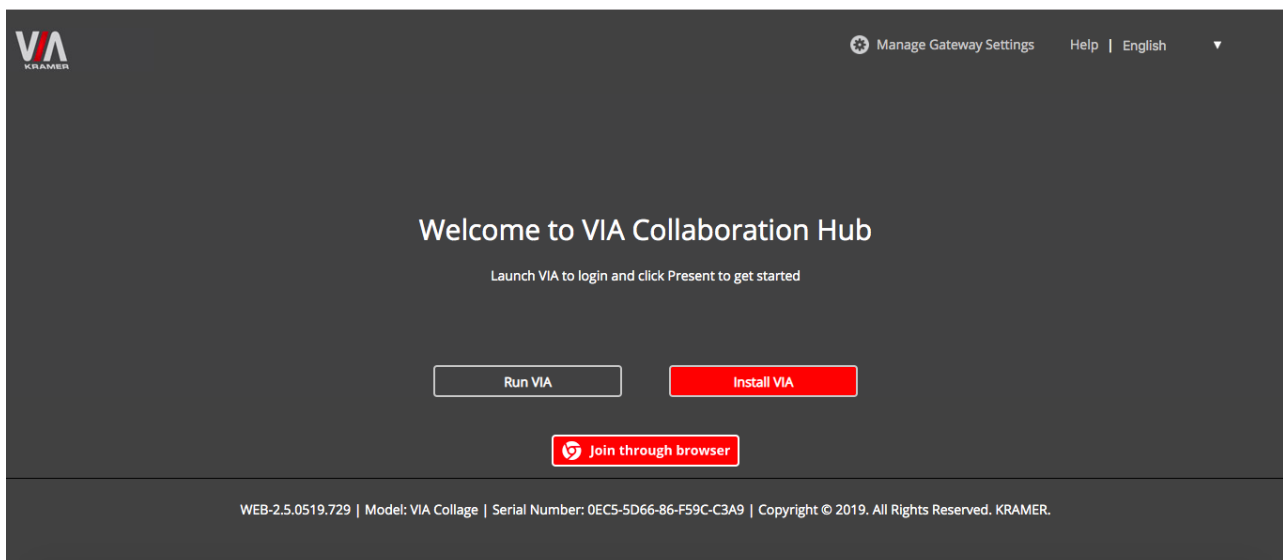

Figure 68: VIA Welcome Page with Join through browser Button

2. Click **Join through browser**.

The next VIA Welcome page appears, notifying that you need to install the VIA Screen Share extension.



If the extension is already installed, the VIA Chrome browser Login page appears.

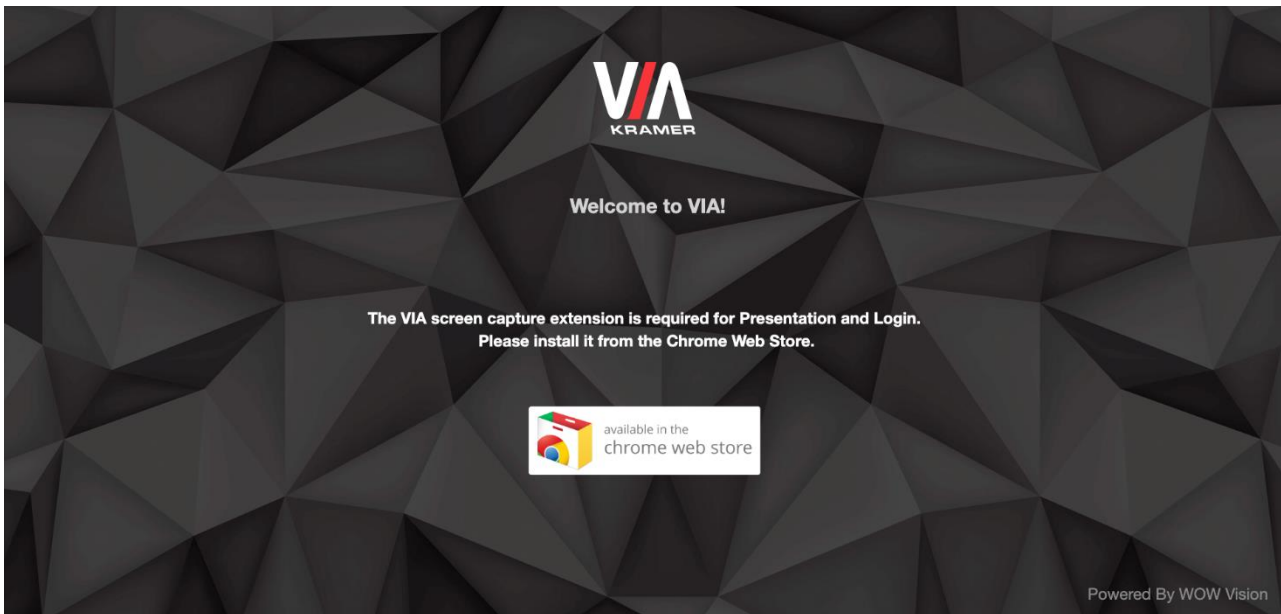

Figure 69: VIA Welcome page with Notification to Install VIA Screen Share Extension

3. Click **available in the chrome web store**.

The Chrome web store page appears.

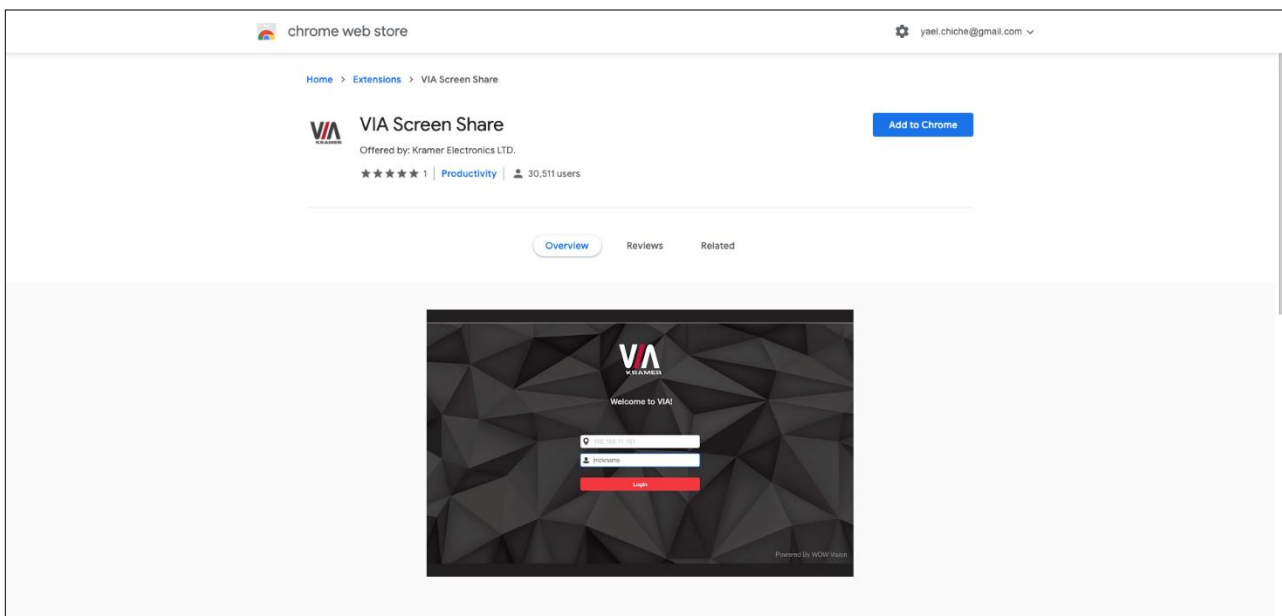

Figure 70: Chrome Web Store Page

4. Click **Add to Chrome**.

The Add “VIA Screen Share” window appears.

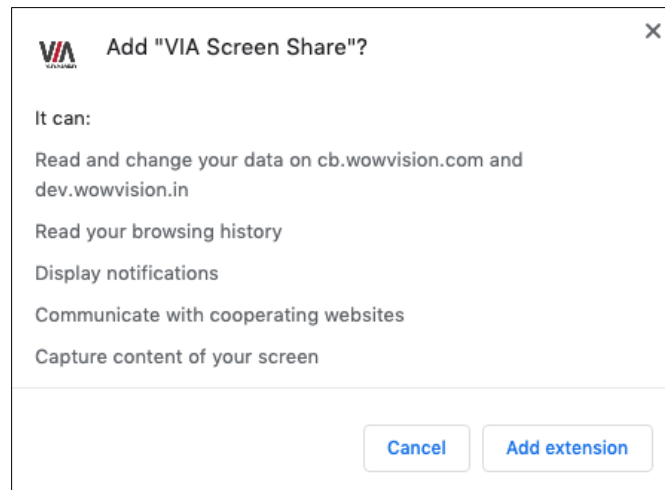

Figure 71: Add “VIA Screen Share” Window

5. Click **Add extension**.

The VIA Screen Share extension is added to your browser.

Running Kramer VIA App Using Chromebooks/Chrome

After you install VIA Screen Share app to your Chrome browser you can now run Kramer VIA app from Chrome and join a meeting.

To run Kramer VIA using Chromebooks/Chrome web browser:

1. Navigate to the **VIA Campus²** IP address with your browser.
The VIA Welcome page appears ([Figure 68](#)).
2. Click **Join through browser**.

The VIA login page appears.

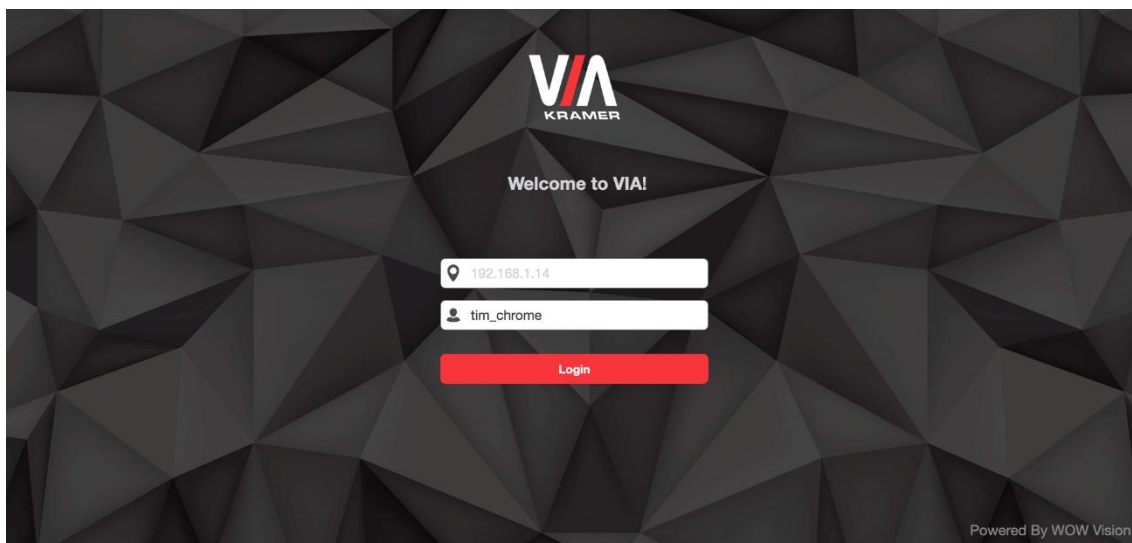

Figure 72: VIA Chrome Browser Login

3. Enter your screen nick name.

4. Click **Login**.

You are logged into the meeting. The VIA Chrome dashboard appears on the left side of the page.

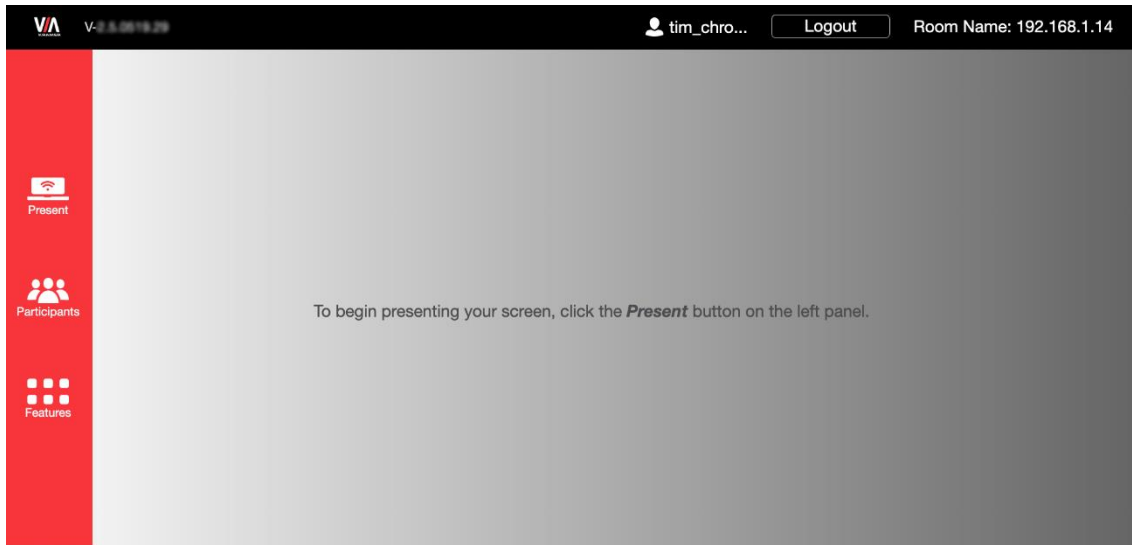

Figure 73: VIA Chrome Dashboard

Joining a Meeting Remotely Using Chromebooks/Chrome

If **VIA Campus²** has an active internet connection, a remote participant can join a meeting remotely, from any location, with the help of a participant in the meeting room.

To join a meeting remotely using Chromebooks/Chrome:

1. A participant in the meeting room, on the same network as **VIA Campus²** navigates to the **VIA Campus²** IP address with their browser.
The VIA Welcome page appears ([Figure 68](#)).
2. This local participant copies the URL from the VIA Welcome page and sends it to the remote participant.
3. The remote participant pastes the URL into their Chrome browser and navigates to the VIA Welcome page.



This URL is unique for each meeting and cannot be used for another VIA meeting.

4. If the remote participant has not installed the VIA Screen Share extension, follow the directions in [Installing VIA Screen Share Extension](#) on page [81](#).
5. Follow the directions in [Running Kramer VIA App Using Chromebooks/Chrome](#) on page [83](#) to join the meeting.



If the Room Code is activated, a participant in the meeting room must tell the remote participant the code for logging in.



The remote participant can use the View Main Display feature (see [Mirroring Main Display on Your Device](#) on page [126](#)) to see the main display in the meeting room. Please note that this feature provides only a visual bridge to the meeting. To hear audio, an additional audio bridge is required.

Running Kramer VIA App Using an Installation File

For easy deployment and installation of Kramer VIA app on participant devices, IT managers can use the msi file (Windows) or dmg file (Apple) available at:

www.kramerav.com/product/VIA_Campus2

For User: Participating in a VIA Meeting

This section explains how to participate in a collaborative meeting using **VIA Campus²** and your personal device.

VIA Campus² enables you to do the following:

- [Joining a VIA Meeting](#) on page [86](#).
- [Mirroring Your Device Screen](#) on page [93](#).
- [Collaborating on Main Display](#) on page [99](#).
- [Streaming Video](#) on page [109](#).
- [Communicating with Participants](#) on page [117](#).
- [Mirroring Main Display on Your Device](#) on page [126](#).
- [Advanced Meeting Functions](#) on page [127](#).

Joining a VIA Meeting

Participants can join (log into) a VIA meeting in the following ways:

- [Joining a VIA Meeting Manually](#) on page [87](#).
- [Joining a VIA Meeting using QR Code](#) on page [91](#).
- [Joining a VIA Meeting Using a VIA Pad](#) on page [92](#).
- [Joining a VIA Meeting Using a VIA NFC Tag for Android](#) on page [92](#).

Joining a VIA Meeting Manually

VIA Campus² enables you to manually enter credentials for joining a VIA meeting.

To join a VIA meeting manually:

1. Connect your device to the same network that VIA Campus² is connected to.
2. Run the Kramer VIA app.
The Connect to a VIA window appears.

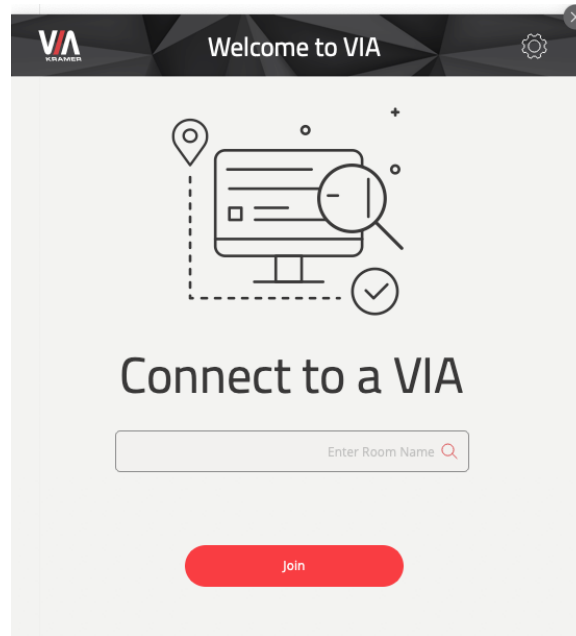

Figure 74: Connect to VIA Screen

- Start typing the name or the IP address of the VIA meeting space to which you want to connect.

The Meeting Spaces list appears.

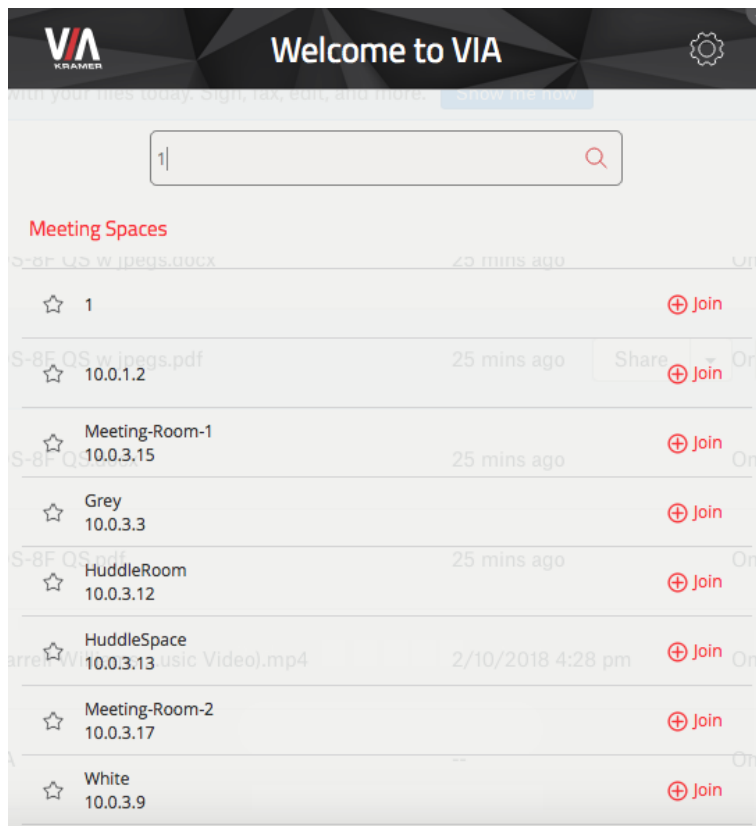

Figure 75: Meeting Spaces List



If the relevant meeting space does not appear on the list, enter the name and click **Join**.



To add a meeting space to your favorites, click the star next to the space.



To delete a meeting space from the list, right-click the space and select **Delete** from the context menu.



One of the following statuses may appear next to a meeting space on the list:

- Room Free for hh:mm minutes – No user is logged in and a meeting will start after the displayed amount of time.
- Available – No user is logged in, broadcast is not enabled, or Calendar is not configured for **VIA Campus²**.
- In Use – A user is logged in or a meeting is in progress (when Calendar is configured).
- In Use. Reserved for <hh:mm> minutes – A meeting is in progress and will end after the displayed amount of time.

- 4. Click **Join** next to the meeting that you want to join.

The Join a Meeting window appears.

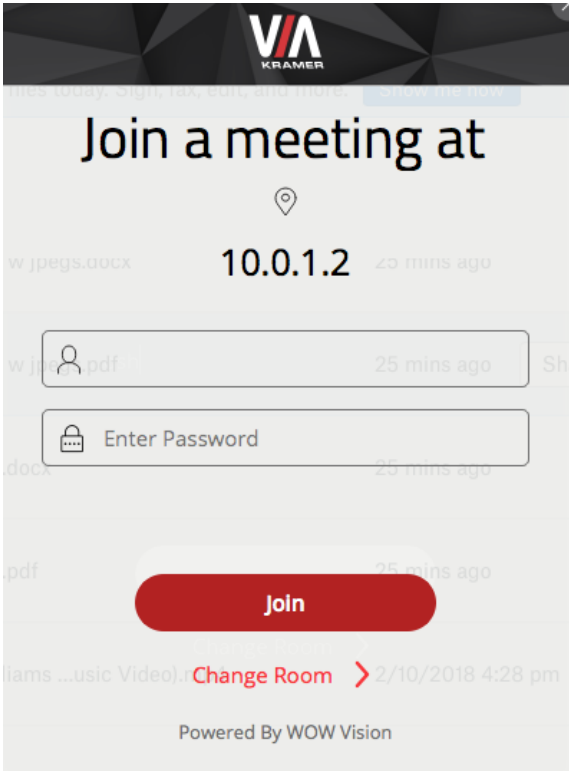

Figure 76: Join a Meeting Window

- 5. In the Nick Name field, enter a nick name (username) for your device (it can be any combination of letters and numbers). This is the name that appears on the main display when you collaborate.

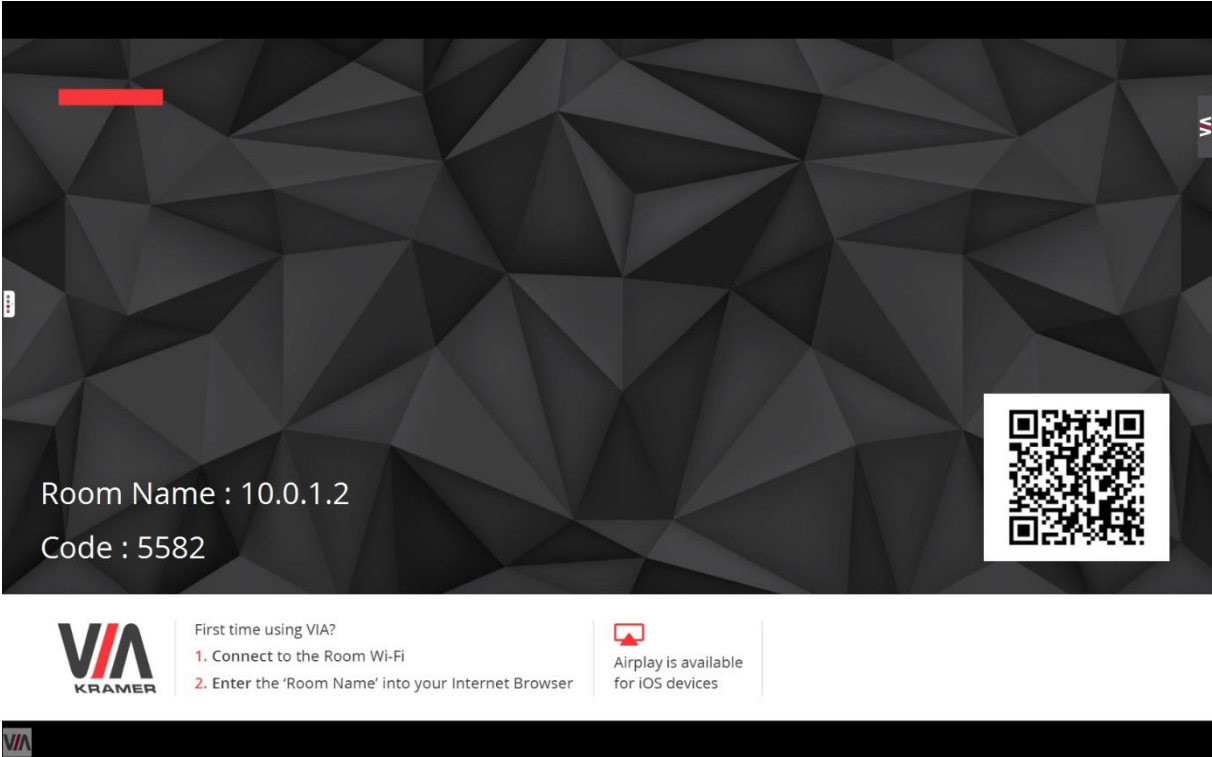



Figure 77: Main Display with Room Code

6. In the Password field, enter the room Code, as it appears on the main display.

 The Room Code can only be seen by those present in the meeting space and it changes regularly (see [Formatting Room Code](#) on page 52). These are security features that ensure that only those present in the room can participate in the presentation.

 You may be required to type a user name and password if Databased Moderator mode is activated (see [Configuring Moderator Mode](#) on page 31). For more information, ask your meeting Web Administrator.

7. Click **Join**.

You are logged into the VIA meeting.

The VIA Dashboard (and taskbar icon for laptops) appears on your device screen.

 The following section may not present the available features for your device. For an updated list of available features for your device, go to: www.true-collaboration.com/products.html#

 Some features only appear when the user is in Moderator Mode.

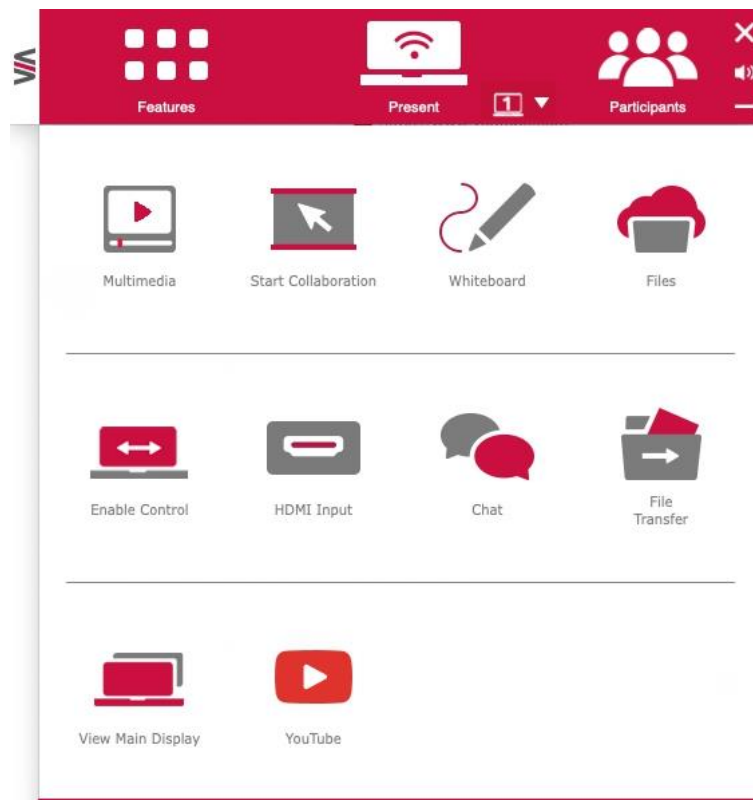

Figure 78 VIA Campus² User Dashboard

The User Dashboard main menu includes:

- Features – Display all available features of **VIA Campus²**.
- Present / Stop Presenting – Mirror or mirroring your screen on the main display.
- For Windows users only - Selection of the Primary / Extended display to present.
- Participants – Display a list of all participants in the session.
- Volume Control – Control the volume of speakers connected to **VIA Campus²**.

Joining a VIA Meeting using QR Code

VIA Campus² enables you to use your mobile device to scan a QR code that appears on the main display to join a VIA meeting.



The following instructions are for iOS and Android mobile device users.

To join a VIA Meeting using the QR Code:

1. Connect your device to the same network as the VIA Campus² and run the Kramer VIA app on your device.
The Kramer VIA Meeting Spaces screen appears.

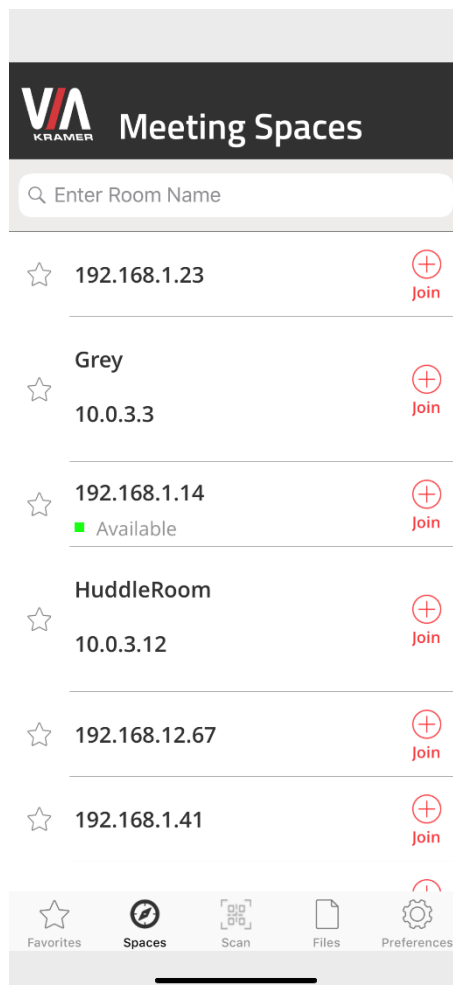



Figure 79: VIA Mobile App Meeting Spaces Screen

2. On the toolbar at the bottom of the screen, tap **Scan**.
A capture screen appears on your device.
3. Scan the QR code that appears on the main display ([Figure 77](#)).
You are automatically logged in to the VIA meeting and the Kramer VIA dashboard appears.

Joining a VIA Meeting Using a VIA Pad

VIA Campus² you to join a VIA meeting using a VIA Pad.

-  Make sure that your **VIA Pad** has been paired with your **VIA Campus²** unit before using it (see [Configuring VIA Pad Settings](#) on page [38](#)).
-  The following instructions are for Windows and Mac OS users.

To join a meeting using a VIA Pad:

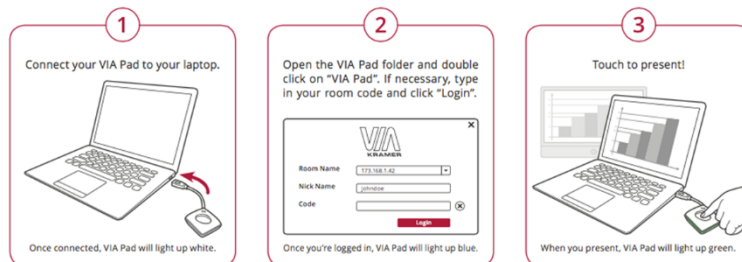

1. Connect your **VIA Pad** to a USB connector on your laptop.
2. Open the **VIA Pad** folder and double-click the **VIA Pad** app. The **Kramer VIA** login window appears.
3. If necessary, type in your room code.
4. Click **Join**.

Your **VIA Pad** lights blue when ready.

The VIA Dashboard and taskbar appear on your device screen ([Figure 78](#)).

5. Use **VIA Pad** to present:
 - Press once – Starts presenting or stops presenting your screen on the main display. When you are presenting, the **VIA Pad** LED banner lights green. When you stop presenting, the LED banner lights blue.
 - Press twice while presenting – Freezes or unfreezes your screen. When your screen is frozen, the **VIA Pad** LED banner flashes green.
 - Long press – Displays your screen in full screen mode on the main display, displacing any other participant screen.

Joining a VIA Meeting Using a VIA NFC Tag for Android

VIA Campus² enables you to join a VIA meeting using a VIA NFC Tag with an Android device.

Writing an NFC Tag

To write an NFC tag:

1. Download the free VIA NFC Writer file from the Kramer Website (www.kramerav.com/support/download.asp?f=50898&pname=via%20nfc%20writer) and install it on your Android device.

2. Open VIA NFC Writer.
The Home screen appears.
3. Type the room name that you want to program and click **Write tag**.
4. When prompted, touch the Android device to the writable tag.
A message appears, confirming that the tag was successfully written.

Joining Using NFC Tag



The **Kramer VIA** app must be installed on your device join a meeting using the NFC tag (see [For User: Running Kramer VIA App](#) on page [80](#)).

To join a VIA meeting using the NFC tag:

1. Enable the NFC feature on your Android device.
2. Touch the Android device to the tag.
You are automatically logged into **VIA Campus²**. The room code is bypassed.
The VIA Dashboard and taskbar appear on your device screen ([Figure 78](#)).

Mirroring Your Device Screen

VIA Campus² enables you to mirror your device screen on the main display using either **Kramer VIA** app, Apple AirPlay Service (when using an Apple device).



The Present feature can be used to present static images or video. However, for high-resolution video, we recommend using the Multimedia streaming feature (see [Streaming Through Kramer VIA App](#) on page [109](#)).

Mirror your device screen on the main display using one of the following methods:

- [Mirroring Laptops and Android Mobile Devices Using Kramer VIA](#) on page [93](#).
- [Mirroring Apple Laptops and iPhones Using iOS/OS X Airplay Service](#) on page [94](#).

You can also use the following features when mirroring via **Kramer VIA** app:

- [Mirroring with Extended Desktop](#) on page [97](#).
- [Mirroring Without Being Interrupted](#) on page [97](#).

Mirroring Laptops and Android Mobile Devices Using Kramer VIA

Laptops and Android mobile devices must have the **Kramer VIA** app installed to mirror their screen. Your mobile device must support Android version 5.1 as a minimum. The latest Android OS version is recommended.



Android mirroring does not support audio. Audio is heard from your device and not from the output of the VIA device.

To mirror your Laptop or Android device screen using Kramer VIA:

1. Connect your laptop or Android device to the network that **VIA Campus²** is connected to.
2. Join the VIA meeting (see [Joining a VIA Meeting](#) on page [86](#))
3. On your VIA dashboard, click **Present**.

A confirmation message appears (Android only).

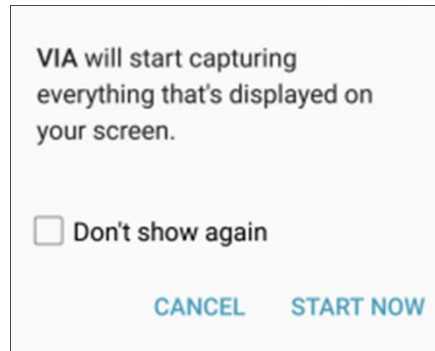



Figure 80: Presenting (Mirroring) Confirmation Message

4. Click **START NOW** to confirm.
Mirroring starts, and your screen appears on the main display.

 Minimize **Kramer VIA** app by clicking the minimize icon on the window or by clicking the Home button of your Android device and open any content on your device to share it on the main display.

 To stop mirroring your screen, re-open **Kramer VIA** app and click **Stop Presenting**.
To pause mirroring (continue to display your screen but stop updating it on the main display), click the pause button to the left of the Stop Presenting button.

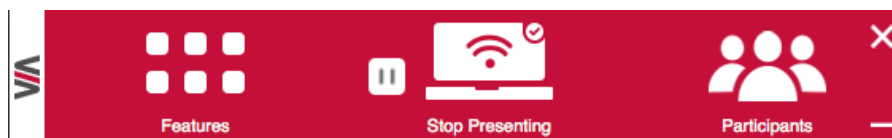

Figure 81: Pause Presenting Button

Mirroring Apple Laptops and iPhones Using iOS/OS X Airplay Service

All participants in a meeting using an Apple device can mirror their screen on the main display using the Apple AirPlay service. No application is required to activate this mode. However, an administrator must enable the iOS mirroring feature in the **VIA Campus²** embedded webpages (see [Configuring iOS Mirroring Settings](#) on page [39](#)).

Minimum requirements for mirroring using Airplay services are:

- iPhone or iPad/Mini iPad – Minimum version iOS 10 (iOS 12 is recommended).
- Mac Books and Apple Computers – Minimum version OS X 10.11 (Mojave is recommended).

To mirror your screen using AirPlay Services:

1. Connect your Apple device to the network that **VIA Campus²** is connected to.
2. For iPhone or iPad/Mini iPad: Swipe from the upper right corner to reveal the Control Center and click **Screen Mirroring**.



Figure 82: iPhone Control Center

For Mac Books and Apple Computers: Click the AirPlay icon on the Apple Menu Bar, located in the top right corner of the screen, near the clock.

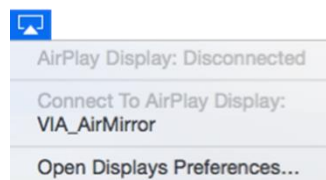

Figure 83: Mac Books/Apple AirPlay Menu

The Screen Mirroring list appears.



Figure 84: iPhone Screen Mirroring List

3. Select **VIA Campus²**'s AirPlay device name (default = **VIA_AirMirror_XXXX**, where XXXX is a random combination of letters and numbers).
If the room code is enabled, a message appears asking you to enter the code.
4. Type the code that appears on the **VIA Campus²** main display (if activated).
Mirroring starts, and your screen appears on the main display.

To disconnect iPhone or iPad/Mini iPad and stop mirroring:

1. Swipe from the upper right corner to reveal the Control Center.





Figure 85: Apple AirPlay Toggle

2. Click **Stop Mirroring**.
Mirroring stops.

Mirroring with Extended Desktop

VIA Campus² enables users to use the main display as an extension of their device desktop to present content. The user's primary screen is not mirrored, allowing the user to keep their notes private on their laptop while mirroring.

-  This feature is available on Windows client laptops only, after installation of the required drivers. When using this feature for the first time, the system asks you to install the drivers. Please accept and follow the on-screen instructions. Once the drivers are installed, reboot your PC to enable the feature.
-  Mac users can use AirPlay to simulate the same behavior (see [Mirroring Apple Laptops and iPhones Using iOS/OS X Airplay Service](#) on page 94).

To mirror with the Extended Desktop feature:

- Click the arrow next to the display icon to the lower right of the Present button on the dashboard ([Figure 78](#)).
An extension of your device desktop appears on the VIA main display.
Drag content beyond your screen to the left and beyond your primary screen to show it on the main display.

-  You can change the relative positioning of the two displays in your device Control Panel under Screen Resolution.

Mirroring Without Being Interrupted

VIA Campus² enables you to mirror content on the main display while preventing other participants from mirroring while using Kramer VIA app.

-  To use the Do Not Disturb feature, it must first be enabled by the Web Administrator using the embedded web pages (see [Activating Do Not Disturb Mirroring Feature](#) on page 40).

To mirror without being interrupted:

1. Become the meeting moderator (see [Becoming Meeting Moderator](#) on page 123).
2. On the VIA dashboard, click **Present**.

You are presenting.



Figure 86: User Dashboard with Do Not Disturb Deactivated

3. Click the gray icon to the right of the Stop Presenting icon.

The icon turns yellow and you enter Do Not Disturb mode.



Figure 87: User Dashboard with Do Not Disturb Activated



You have full access to all features. The other participants see a modified user dashboard that only allows access to the Participants list. Other icons, except View Main Display, are disabled.

4. Click the yellow icon.
Do Not Disturb is deactivated and the other participants return to full functionality.

Collaborating on Main Display

VIA Campus² provides state-of-the-art collaboration functionality, enabling meeting participants to interact with content displayed on the main display, annotate shared content, take control of another participants computer and more. It enables up to 254 meeting participants to collaborate – utilizing a compatible external wireless network.

Interacting with Main Display

VIA Campus² enables participants to interact with the main display as if it were a part of their own device screen, using their own mouse, keyboard and touch screen.

To interact with the main display for a device with a mouse and keyboard:

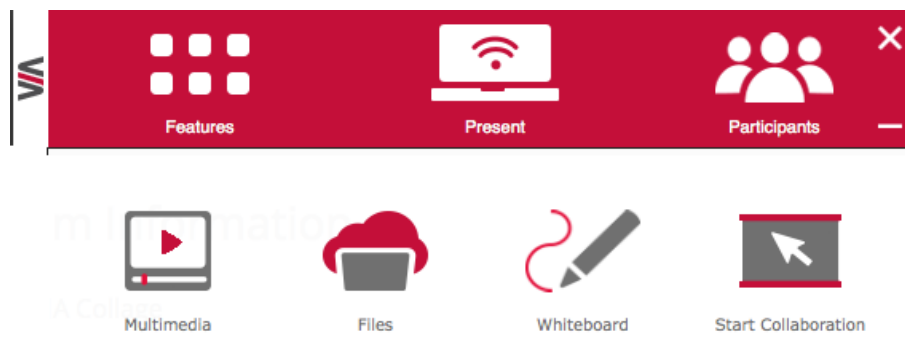

Figure 88: VIA Dashboard – Features > Start Collaboration

1. On the **VIA** dashboard, click **Features** > **Start Collaboration**.
A red check appears and the icon changes to Stop Collaboration.

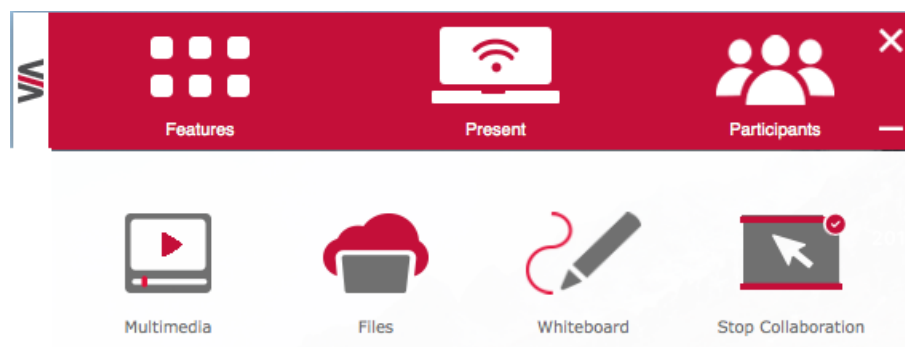

Figure 89: Stop Collaboration in the Dashboard Features

A floating Stop Collaboration icon also appears in the upper right corner of your screen.



Figure 90: Floating Stop Collaboration Icon



Click and drag the floating **Stop Collaboration** icon to another location on your screen, if necessary.

2. Move your cursor past the top of your device screen.
Your cursor appears on the main display with your nickname next to it.

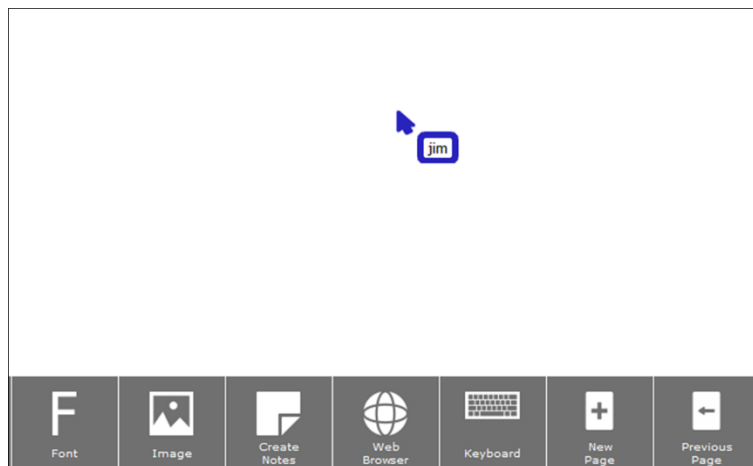



Figure 91: Collaboration Cursor on the Main Display

3. Use your cursor as a pointer or operate any of the features from the main display dashboard and use your keyboard to type text on the main display, when necessary.

 To use your cursor to control your own device, move your cursor past the bottom of the main display until it appears on your device screen.

To interact with the main display for a device with a touch screen:

 For laptops with touchscreens, you must enable the touch screen for collaboration (see [Enabling Touch Screen Collaboration](#) on page [107](#)).

1. On the VIA dashboard ([Figure 89](#)), click **Features > Start Collaboration**.
A virtual touchpad appears on your device screen.

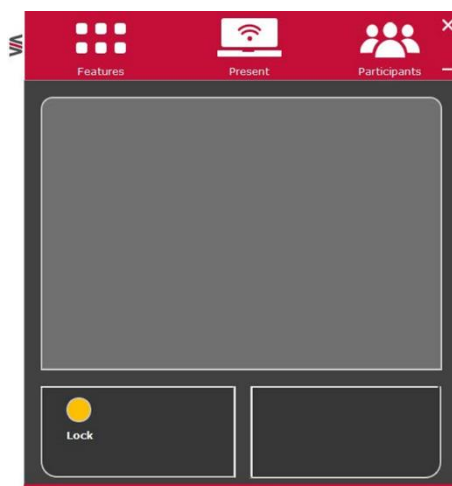

Figure 92: Virtual Touchpad

2. Use the top section of the touchpad to move the mouse.
3. Tap the bottom right and bottom left sections for right-click and left-click.
4. Tap the yellow **Lock** button to lock the left-click in pressed position and move the cursor using the top section of the touchpad for dragging or selecting.

The left-click button turns red and remains locked until you remove your finger from the touchpad.

To stop collaborating:

- For a laptop: Click **Stop Collaboration** in the dashboard Features or the floating icon. Collaboration stops and your cursor disappears from the main display or the virtual touchpad disappears from your screen (when using a touchscreen).
- For a mobile device: Click your device's **Features** button. Collaboration stops and the virtual touchpad disappears from your screen.

Using Whiteboard Feature

VIA Campus² enables you to use a virtual whiteboard on the main display. Multiple participants can use the whiteboard concurrently to draw, present images, and annotate content.

Starting Whiteboard Feature

To start the Whiteboard feature:

- On the **VIA** dashboard, click **Features > Whiteboard**.
A whiteboard session starts on the main display.

Joining Whiteboard Session

VIA Campus² enables any meeting participant to join a whiteboard session via their own device and contribute by using the whiteboard tools. Multiple users can simultaneously interact with the whiteboard content on the main display.

To join a Whiteboard session:

1. On the **VIA** dashboard, click **Features > Whiteboard**.
The whiteboard appears on the main screen and your Collaboration feature starts.
2. Drag the cursor past the top of your screen to the main display.
You have joined to the Whiteboard session and can use the annotating tools.

Whiteboard Tools



Figure 93: Whiteboard Toolbar











Icon	Action
Pen	Draw on the whiteboard. Click icon corner to select pen color and thickness.
Shapes	Draw a line, rectangle, or circle. Click the lower right corner to select the shape, color and line thickness.
Eraser	Erase annotations. Click icon corner to select eraser thickness and to erase the entire whiteboard.
Highlighter	Highlight text or objects on the whiteboard in yellow.
Capture Area	Select an area and paste in onto the current whiteboard page or a new page.
Arrow	Select, drag, resize an annotation, image or text box.
Text	Add a text box. Click the lower right corner to select the font.
Font	Format the currently selected text box.
Create Notes	Type notes that are attached to the current whiteboard page.
Web Browser	Opens your default web browser with annotation tools.
Keyboard	Open a virtual keyboard to insert text into a text box.
New Page	Create a new whiteboard page.
Current Page	Shows the number of the currently displayed page. Click the lower right corner to move to the previous or next page.
Save	Save all your whiteboard pages in PDF or JPEG format.
Show desktop	Displays the main display with all running applications. The user can also annotate any content on the main display and add it to a whiteboard page (see Show Desktop on page 103).
Close	Close the Whiteboard.



The whiteboard toolbar can be moved to the bottom (and back to top) of the display by clicking the small arrows on the right side of the toolbar

Show Desktop

Show Desktop allows you to hide the whiteboard and to navigate freely on the VIA desktop. A toolbar is available for making annotations on the VIA desktop and capturing an object. For example, capture an area of the screen and add it as an object in the current Whiteboard page.

Icon	Name	Action
	Pencil	Draw on the whiteboard. Click the lower right corner to change the color and the line thickness.
	Shapes	Draw a line, rectangle, or circle. Click the lower right corner to select the shape, color and line thickness.
	Eraser	Erases what you have drawn on the whiteboard. Click the lower right corner to change the eraser thickness.
	Highlighter	Highlight text or objects on the main display in yellow.
	Selection	Select and move an object.
	Window Capture	Capture a screenshot of the active window.
	Area Capture	Click and drag the mouse to capture a rectangular screenshot.
	Save	Save your activity in either. jpg or. pdf format
	Show/Hide	Show/Hide annotations.
	Whiteboard	Switch to full screen whiteboard mode.
	Exit	Exit the whiteboard.

Showing Content from External Wired Device

VIA Campus² PLUS enables you to show content on the main display from an external device connected to the HDMI IN connector. The HDMI input can be used for a stand-alone device or switcher with multiple sources.

To show content from an external wired device:

- Connect the device to the VIA Campus² PLUS HDMI IN Connector ⑥.
If there are no other presenters, your content appears on the entire screen. If there are other presenters, your content appears on the main display as one user screen.

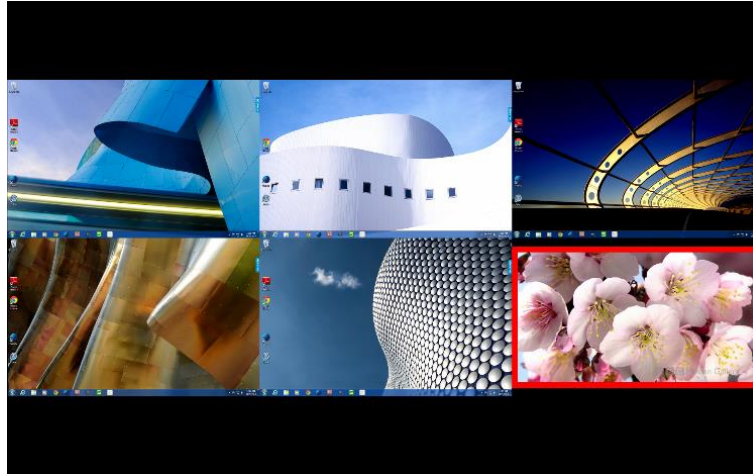

Figure 94: HDMI Input Content as a one of the User Screens on the Main Display

A check appears on the HDMI Input icon on the dashboard features.



Figure 95: HDMI Input Feature Icon Enabled



On the VIA dashboard ([Figure 78](#)), click the HDMI Input icon to toggle showing and stopping to show your display.

Showing HDMI Input as Floating Window



This feature is accessed only from the Gateway Dashboard (see [Using Gateway Dashboard](#) on page [127](#)).

To show the HDMI Input content as a floating window on the main display:

- On the VIA gateway dashboard ([Figure 122](#)), click **Features > PIP**. A check appears on the PIP (Picture In Picture) icon and the content from the connected device appears on the main display as a floating window that can be moved to any position.



Figure 96: PIP Feature Icon Enabled

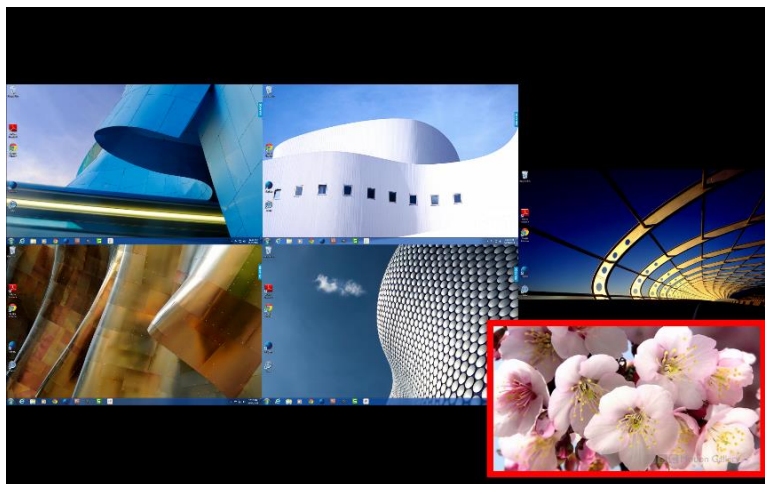

Figure 97: HDMI Input Content as a Floating Window on the Main Display

Enabling Control

VIA Campus² enables the admin to take control of a participant's computer (Windows or Mac OS). (In our example, [Figure 98](#), user Dave is presenting and the Admin has taken control of Dave):

The admin can work on Dave's system as he has taken control (Admin can play media or work on a document or presentation file collaboratively with Dave).

Any other participant who wants to take control or collaborate with Dave's system can click the Start Collaboration icon and drag his laptop mouse to the top and off their local screen. That cursor now moves to the VIA Campus² unit and appears on the main display of Dave:

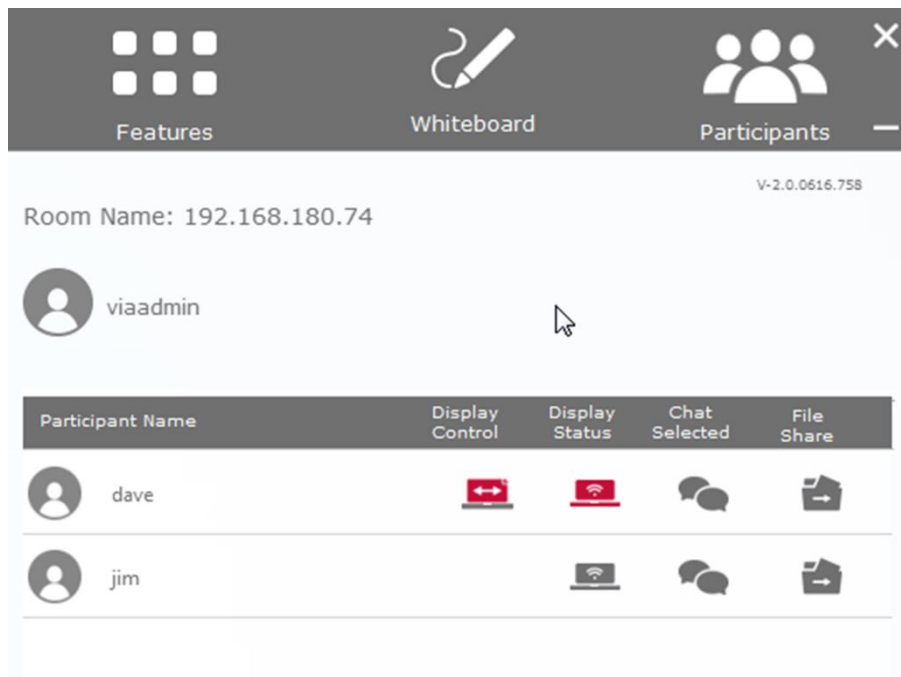

Figure 98: Enable Control

Enabling Touch Screen Collaboration

VIA Campus² enables you to use the touchscreen on your laptop for collaboration (see [Collaborating on Main Display](#) on page 99).

To enable laptop touch screen collaboration:

1. Click the VIA icon in your computer taskbar.

The taskbar menu appears.

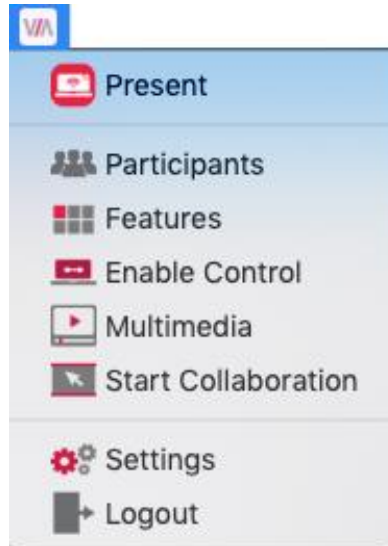

Figure 99: Kramer VIA Taskbar Menu

2. Click **Settings**.

The Client Preferences screen appears.

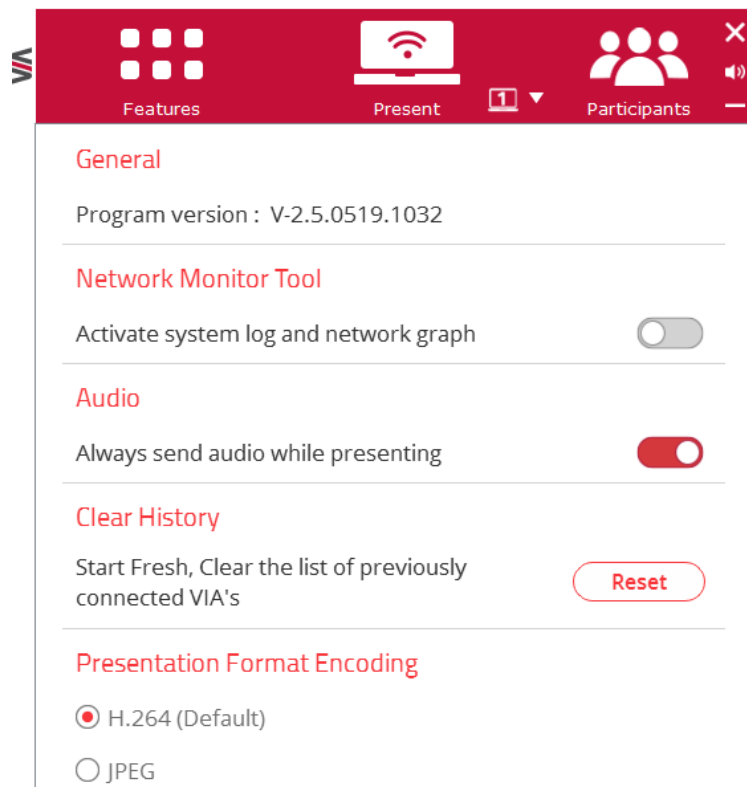



Figure 100: Client Preferences Screen

3. Select the **Use touch screen for collaboration** checkbox.
Touch screen collaboration is enabled.

Collaboration Scenario

 For simplicity, a scenario with only two users is described below.

In the following scenario:

- User #1 is showing content from their device.
- User #2 is collaborating with User #1's content.

The scenario proceeds as follows:

1. Collaboration begins when User #1 presents content on the main display.
2. With content being shown, User #1 then selects **Enable Control** from the dashboard Features. At this point, all connected users have full control of User #1's computer.
3. Once Enable Control is selected, a red check mark appears on the upper-right of the icon.

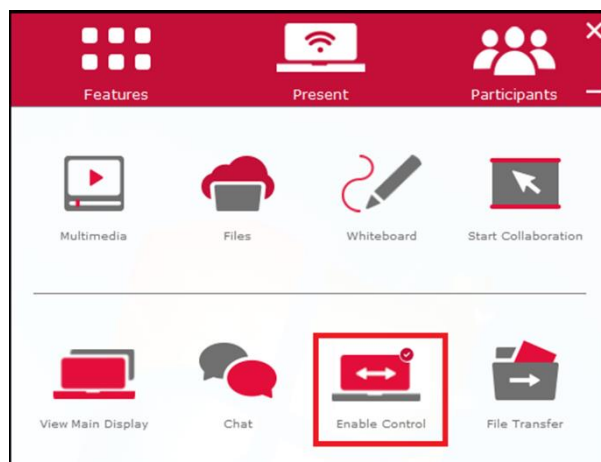

Figure 101: Enable Control Icon with Check

 At any time, User #1 can click **Enable Control** again to stop other users from controlling their computer.

- User #2, who can now see User #1's content on the main display, clicks **Start Collaboration** from the dashboard Features.

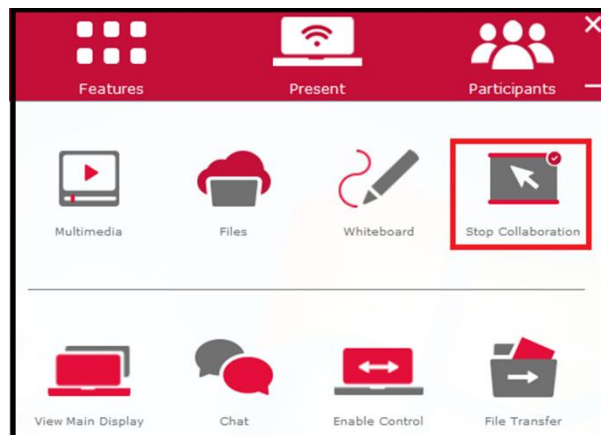

Figure 102: Clicking Start Collaboration

- User #2 moves her cursor to the top of their own screen (as if VIA's main display was an extended desktop) onto the main display. An additional cursor with User #2's nickname and a unique color appears on the screen.
- At this point, User #2 can access and make changes to the content displayed from User #1's computer.



User #2 has complete access to User #1's computer, even beyond the content currently being displayed.

- Once the collaborative session has ended, User #1 saves the content to his hard drive. If desired, User #1 can use the dashboard File Transfer feature to share the edited document with all participants.
- User #1 now clicks the **Enable Control** icon, denying access for other participants to control or modify his content or device.

Streaming Video

VIA Campus² provides the following options for streaming video from your device to the main display:

- [Streaming Through Kramer VIA App](#) on page [109](#).
- [RTSP Streaming Through VLC](#) on page [112](#).
- [RTP Streaming Through VLC](#) on page [116](#).

Streaming Through Kramer VIA App

VIA Campus² enables users to stream video to the main display at a full HD 1080p/60fps rate. The video is obtained from the client device without being transferred to VIA Campus².



VIA Campus² features a 10Mbps maximum video bitrate for 30fps or 60fps videos and handles video files of up to 8GB.



The default encoding format is H.264. If your device operating system does not support H.264 encoding, enable JPEG encoding (see [Changing Encoding Format](#) on page [129](#)).

Stream video from your device to **VIA Campus²** using one of the following methods:

- [Streaming Media File Using Multimedia Feature](#) on page [110](#).
- [Streaming by Dragging and Dropping Media to VIA Dashboard Logo](#) on page [110](#).
- [Streaming from YouTube](#) on page [111](#).

Streaming Media File Using Multimedia Feature

To stream a media file using the multimedia feature:

1. Click **Multimedia** in the features menu of your VIA dashboard ([Figure 78](#)).
The Multimedia player window appears.
2. Click **Add Media**.
A system file browser appears.
3. Select the relevant video file and click **Open**.
The file appears in the My Media table.
4. Double-click the media file in the table or click the play button.
The video plays on the main display.

Streaming by Dragging and Dropping Media to VIA Dashboard Logo

To stream by dragging and dropping Media to the VIA Dashboard Logo:

- Drag a media file from your device to the small VIA logo on the upper left of your VIA dashboard ([Figure 78](#)).
The video plays on the main display.



The video must be dragged directly onto the logo, not to the left, right, below or above the logo.

Streaming from YouTube

To stream from YouTube:

1. Click **YouTube** in the features menu of your VIA dashboard ([Figure 78](#)). The YouTube player window appears.

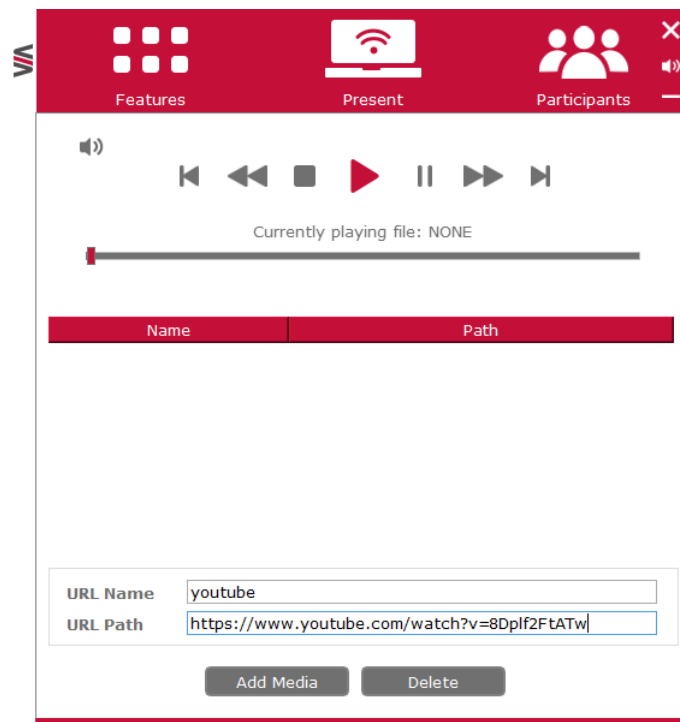

Figure 103: YouTube Player Window

2. In the URL Name field, enter a name for the video.
3. In the URL Path field, enter the web address for the YouTube video. The name and path of the URL are added to the table above.
4. Click the URL in the table or the play button. The video plays on the main display.



When showing videos through the **Kramer VIA** app, the video is not transferred from your device to the VIA unit. All videos are encoded directly on your device through the app and then streamed from your device to the VIA unit. The VIA unit then decodes the streamed file for playback.



Video files can also be shared from your device to the main display by using a native media player such as QuickTime and/or Windows Media Player and the Present feature (see [Mirroring Your Device Screen](#) on page [93](#)). However, when using this method, you may experience lower frame rates, inconsistent playback and increased latency, depending on your laptop system performance.

RTSP Streaming Through VLC

The Real Time Streaming Protocol (RTSP) is a network control protocol designed for use in entertainment and communications systems to control streaming media servers. The protocol establishes and controls media sessions between end points. Clients of media servers issue commands like play and pause, to facilitate real-time control of playback of media files from the server.

VIA Campus² supports RTSP. Media played locally on a computer can be streamed on VIA Campus², provided the computer and VIA Campus² are on connected networks.

To Configure RTSP Streaming using VLC Media Player:

1. Open VLC Media Player.

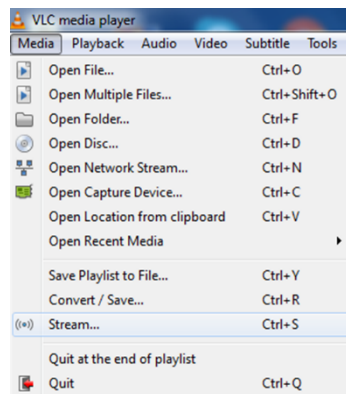

Figure 104: VLC Media Menu

2. Click **Media > Stream**.
The Open Media window appears.

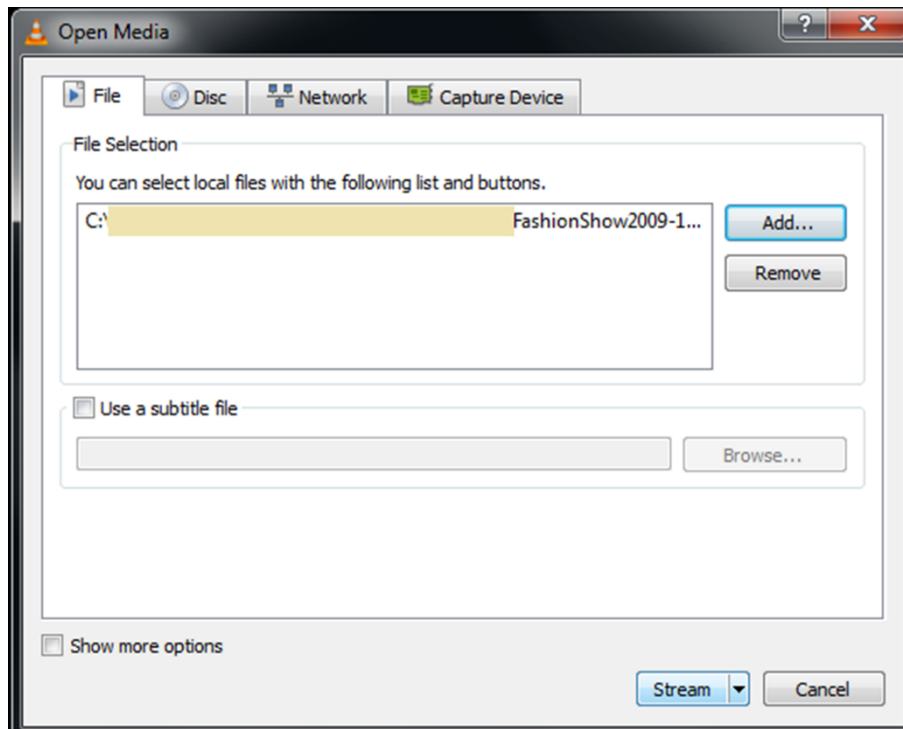

Figure 105: Open Media Window

- 3. Click **Add** and select a file to stream and click **Stream**.

The Stream Output/Source window appears.

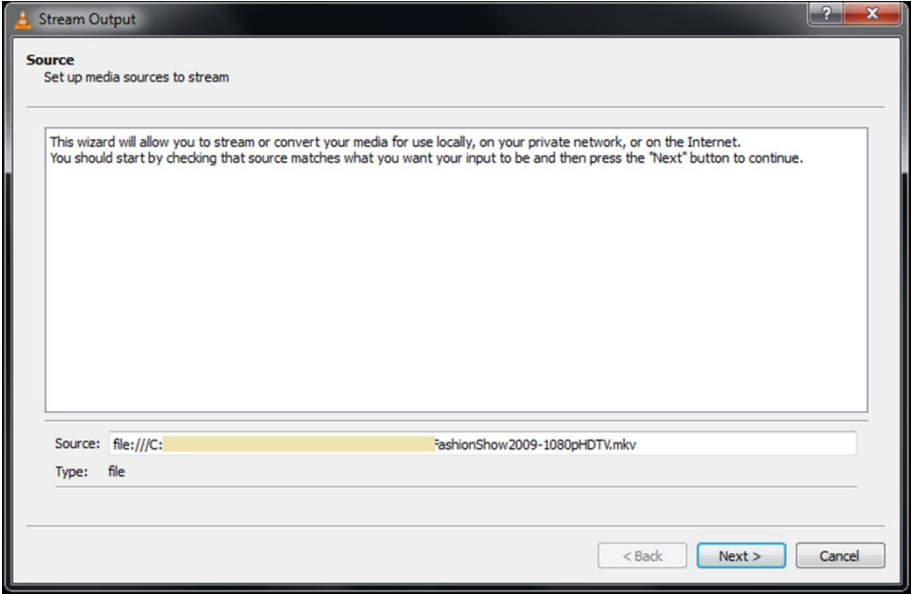

Figure 106: Stream Output/Source Window

- 4. Click **Next**.

The Stream Output/Destination Setup window appears.

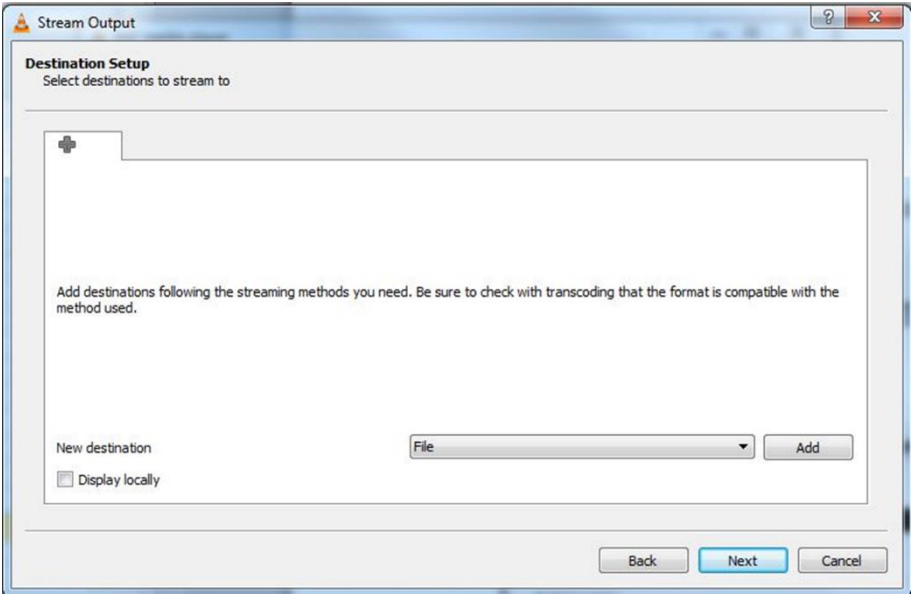

Figure 107: Stream Output/Destination Setup Window

- 5. Select **RTSP** from the New Destination drop down and click **Add**.
The RTSP tab appears.

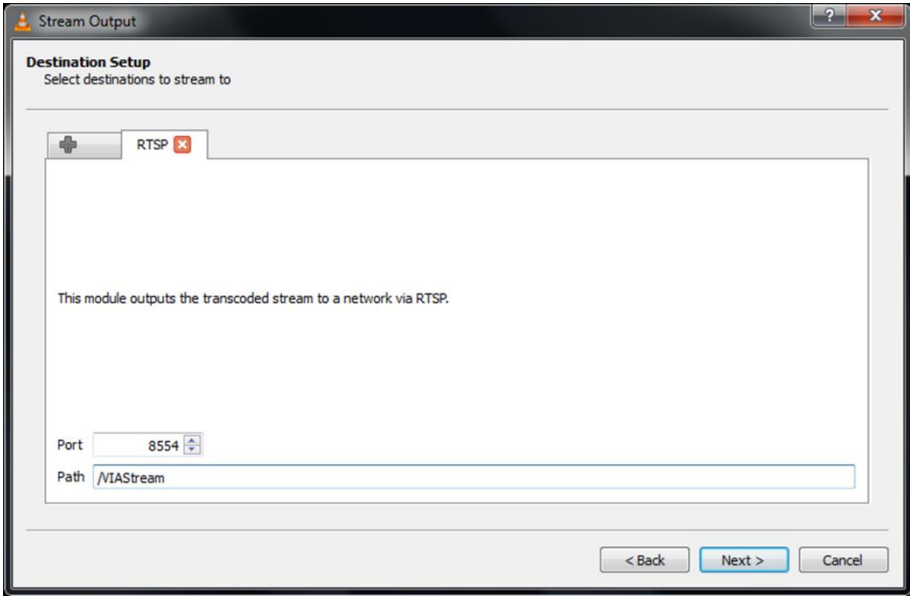

Figure 108: Stream Output/Destination Setup RTSP Tab

- 6. Type a short name to be used as a Path and click **Next**.
The Stream Output/Transcoding Options window appears.

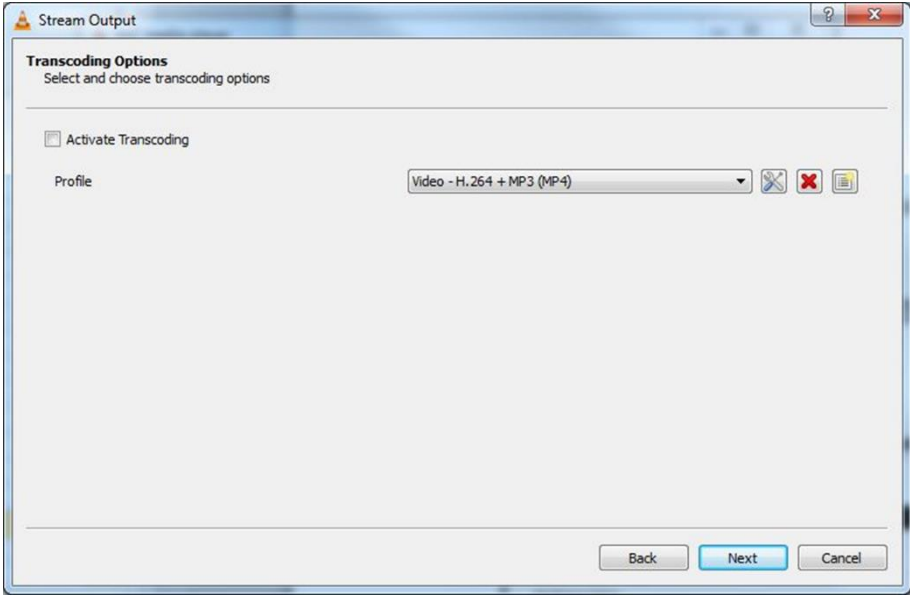

Figure 109: Stream Output/ Transcoding Options Window

7. Clear the Activate Transcoding checkbox and click **Next**.

The Stream Output/Option Setup window appears.

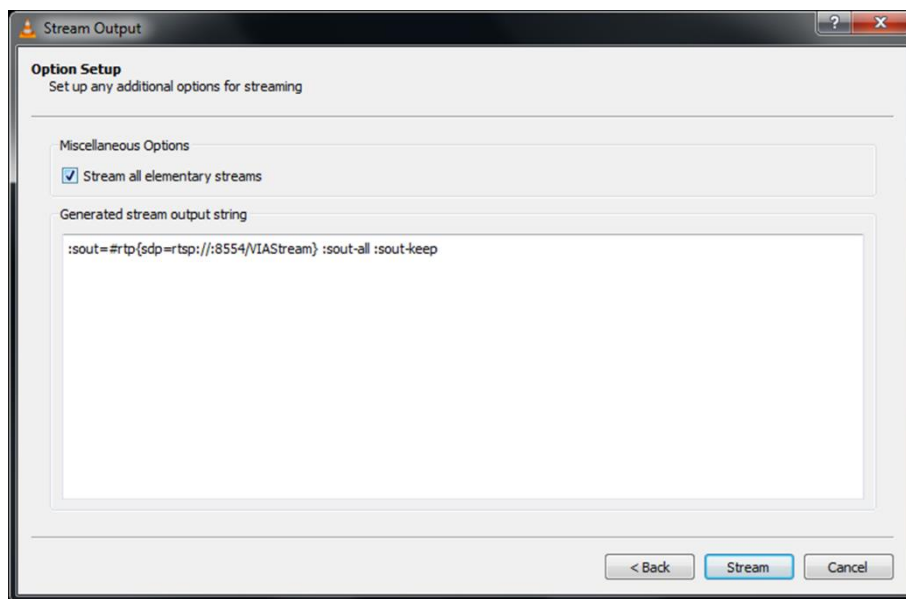

Figure 110: Stream Output/Option Setup Window

8. Select **Stream all elementary streams** and click **Stream**.
9. On the **VIA** dashboard, click **Features > Multimedia > Streaming Player**. The Streaming Player appears.

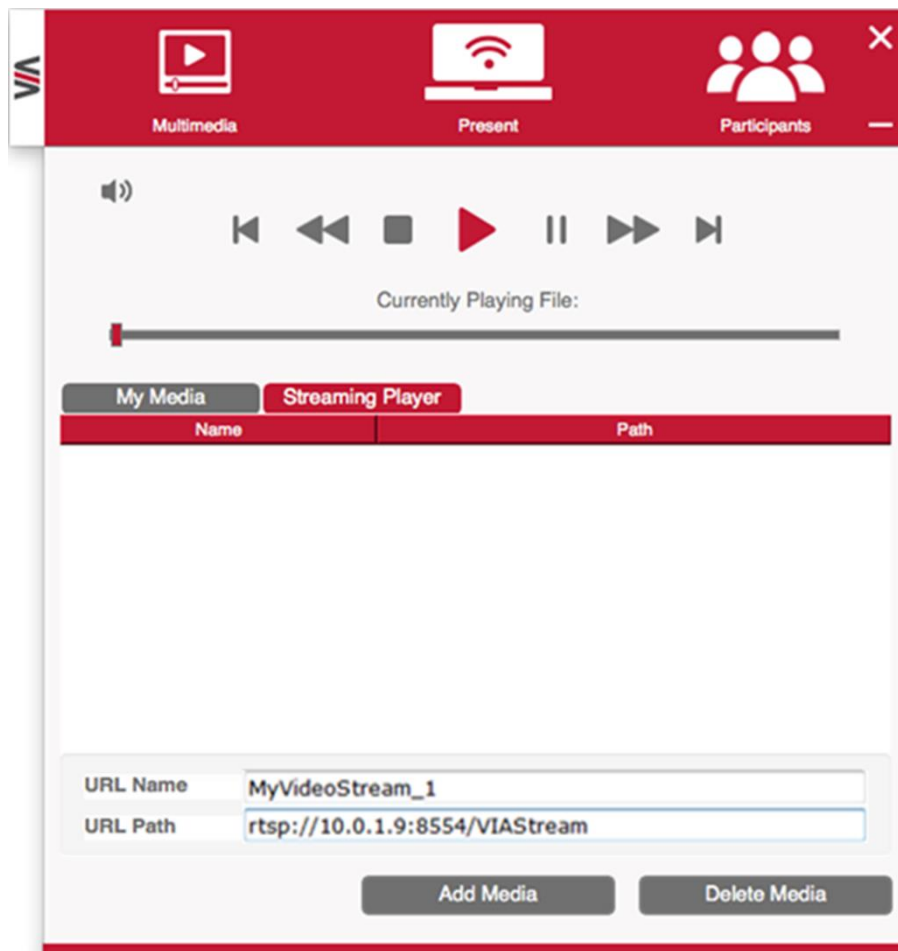

Figure 111: Streaming Player Screen

10. Type a URL name in the following format:
rtsp://<local computer IP address>:8554/<name mentioned in step 6>.
11. Click **Add Media**.
12. Select **RTSP stream** and click the play button to stream this media on **VIA Campus²**.
RTSP Streaming using VLC Media Player is configured.

RTP Streaming Through VLC

The Real-time Transport Protocol (RTP) is a network protocol for delivering audio and video over IP networks. RTP is used extensively in communication and entertainment systems that involve streaming media, such as telephony, video teleconference applications, television services and Web-based push-to-talk features.

VIA Campus² supports RTP. Media can stream on a **VIA Campus²** unit, provided the computer and **VIA Campus²** are on connected networks.

To stream RTP using VLC:

1. Open VLC.
2. Click **Media > Stream**.
3. Click **Add** and select a file to stream and click **Stream**.
4. Click **Next** on the next screen.
5. Choose RTP/MPEG Transport Stream from the New Destination drop down and click **Add**.
6. Enter **VIA Campus²** unit's IP address and click **Stream**.
7. Open **VIA Campus²** client and click **Features > Multimedia > Streaming Player**.
8. Type a name as the URL name.
9. The URL path takes the form: Rtp: //<**VIA Campus²** IP address>:5004.
10. Click **Add Media**.
11. Select the RTP stream and click the play button to stream this media on **VIA Campus²**.
RTP Streaming using VLC is configured.



If a URL is already present in the streaming list above, VIA client generates a warning for both modes - RTP and RTSP.

Communicating with Participants

VIA Campus² enables you to communicate with participants through chat, file sharing and becoming moderator of the meeting.

Chatting with Participants

VIA Campus² enables you to exchange text messages with other meeting participants.

To chat with another meeting participant:

1. Click **Participants** on the **Kramer VIA** app dashboard.
The Participants list appears.

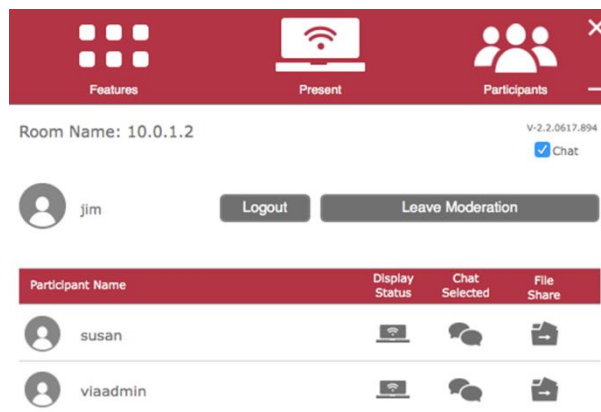

Figure 112: Kramer VIA app Dashboard Participants List



If there is a meeting moderator with enable/disable chat access (see [Configuring Moderator Mode](#) on page 31), verify that Chat is selected in the upper right corner of the Participants list.

2. Click the chat icon for the desired participant.
The chat window appears.

3. Type your message at the bottom of the window and click **SEND**.
Your message is sent to the selected meeting participant.

The selected participant receives your message.

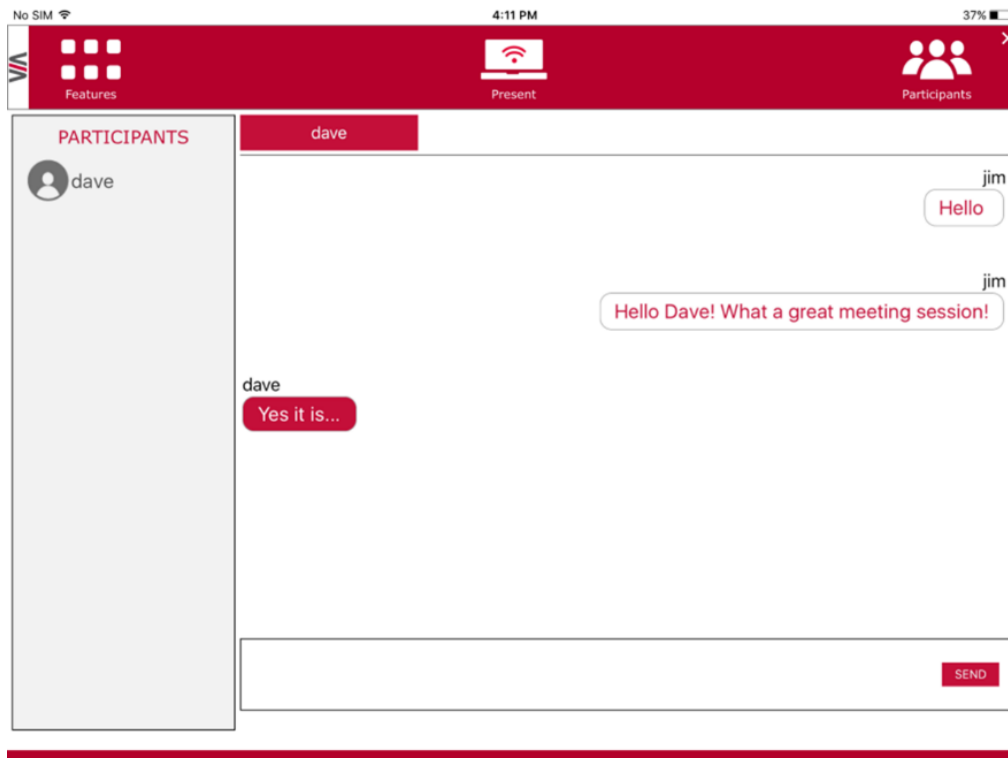



Figure 113: Chat Window



You can check for active chat sessions by clicking **Features** > .

Sharing Files

VIA Campus² enables you to share files from your device or from the VIA Cloud (see [Managing VIA Cloud Files](#) on page 119) with other meeting participants.

Sharing Files from Your Device

To share a file from your device:

1. On the VIA Dashboard, click **Participants** or click the **File Transfer** feature icon. The Participants list opens.
2. Click the file transfer icon  for the desired participant with whom you wish to share a file.
A file browser appears.

3. Select the relevant file.

A progress bar appears showing the file transfer progress as it is saved to the VIA Cloud.

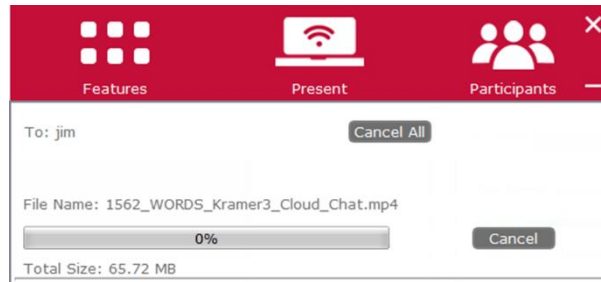

Figure 114: Admin File Sharing

4. The target participant receives notification of the shared file and selects a location to save the file.

The file is transferred and saved on the receiving participant's device.

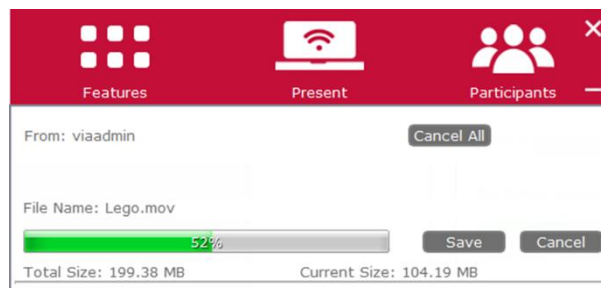

Figure 115: User File Sharing



The receiving participant can view and cancel a file that is in the process of being transferred by clicking the File Transfer icon on the Dashboard.

Sharing Files from VIA Cloud

VIA Campus² enables you to share files from the VIA Cloud (see [Managing VIA Cloud Files](#) on page 119) with other meeting participants.

To share files from the VIA Cloud:

1. On the Dashboard, click **Features > Files**.

A dialog box appears.

2. Select one of the following options.

- **Share the file just to VIA** – Opens it locally on **VIA Campus²** to view and edit.
- **Share the selected file with all connected participants.**

Managing VIA Cloud Files

VIA Campus² enables you to save files to a central directory so that they can be accessed by and shared among participants in a VIA meeting. This directory is referred to as the VIA Cloud and is located in the **VIA Campus²** internal memory.

To manage VIA Cloud files:

- On the Dashboard, click the **Files** feature icon.

The VIA Cloud window appears.

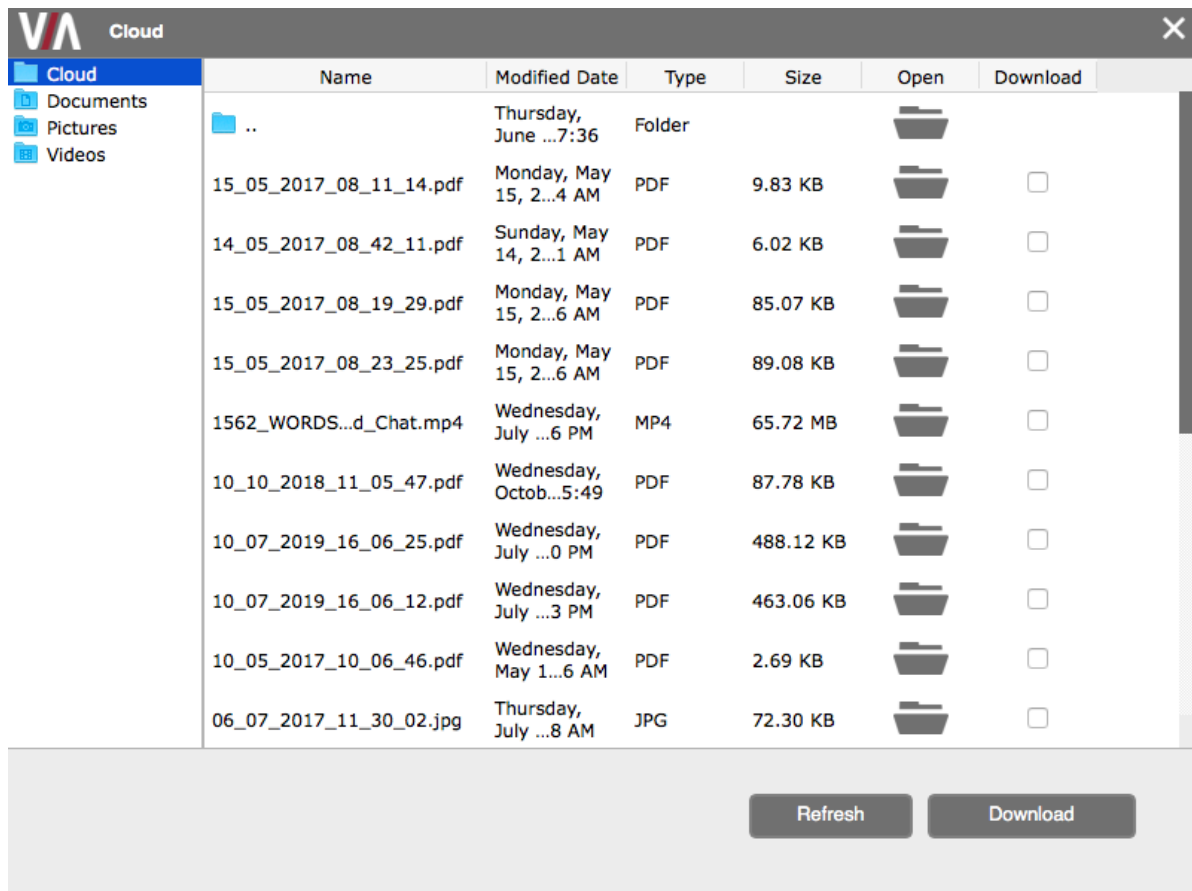

Figure 116: Shared Files on Cloud

- To delete a single file from the VIA Cloud directory, click the delete icon and confirm the permanent deletion warning message.
- To delete all files from the VIA Cloud directory, click **Clean Directory** and confirm the permanent deletion warning message.

Using a Linked Cloud Storage Service

VIA Campus² enables you to link your cloud service (Google Drive, Dropbox or OneDrive) account to Kramer VIA app. You can then enjoy full access to your online documents and upload VIA content to your cloud storage.



This feature is available for mobile devices only.

To use content from your linked cloud storage service:

1. Select a file from your cloud service.
2. Select one of the following options:
 - **Open** – Open the file on your screen and “Present” to share it on the main display
 - **Download** – Create a copy of your online file to easily access it from your VIA Multimedia Feature
 - **Share** – Share the selected file using your preferred mailing service

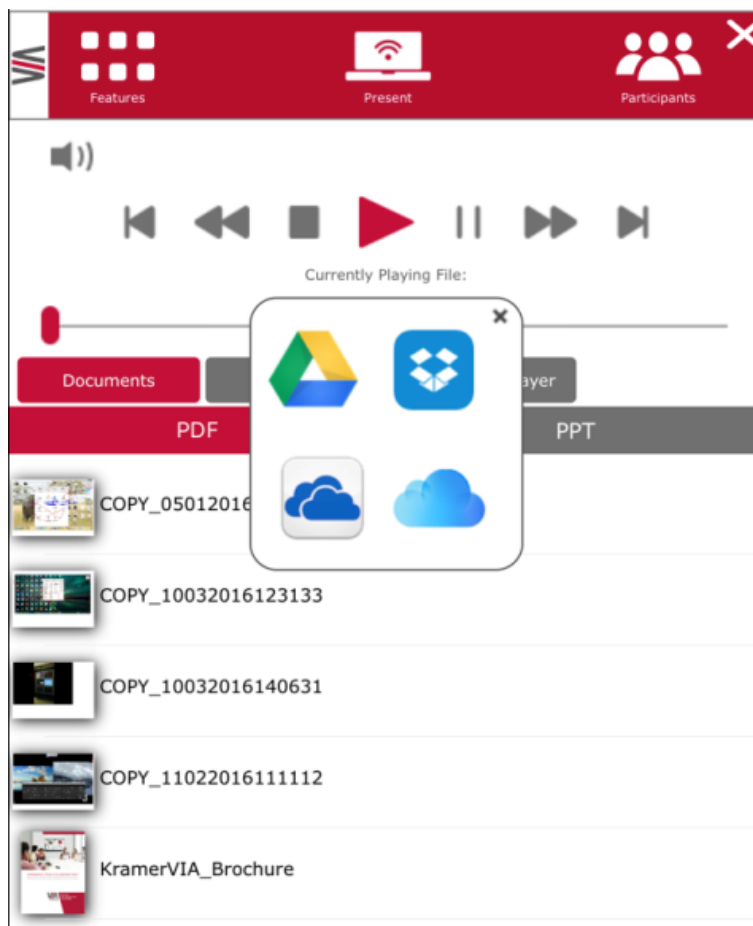

To upload a multimedia file to your linked cloud service:

Alternatively, enjoy the ability to select one file saved in your VIA Multimedia feature (photo, document or video) and choose to upload it to your cloud service account, for later use.

Managing VIA Files for Mobile App

VIA Campus² enables you to upload, view, edit, delete and share files that you use for your VIA meetings.



To share files with other meeting participants, see [Sharing Files](#) on page [118](#).

To Manage VIA files from Kramer VIA mobile app:

1. On the toolbar at the bottom of the Meeting Spaces screen ([Figure 79](#)), tap **Files**.
The Files screen appears.

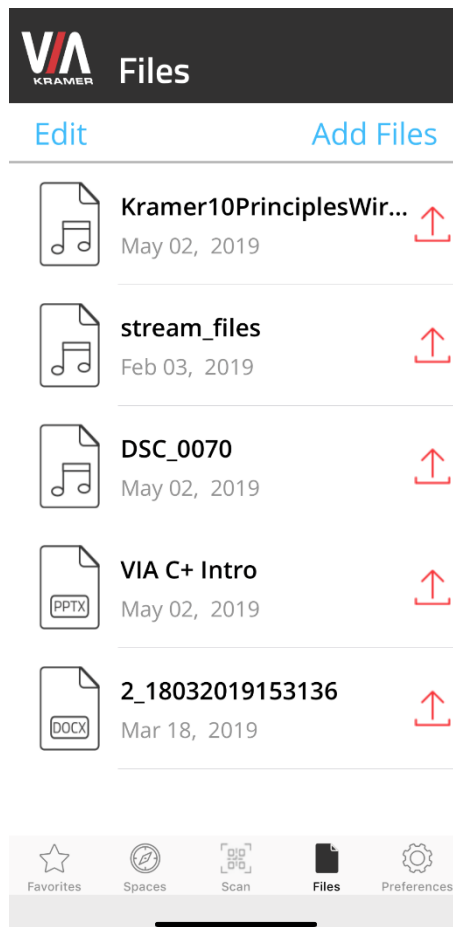

Figure 117: Kramer VIA Mobile App Files Tab

2. Do one of the following:
 - Tap the up arrow next to the relevant file to share it through email or another app.
 - Tap a file to select it and tap **Edit**, to open the file for editing.
 - Swipe the relevant file to delete it.
 - Tap **Add Files** to add to your VIA files.

Using Web Browser

VIA Campus² enables you to use a web browser from the VIA dashboard without exiting the VIA session.

To use a web browser:

- On the VIA Gateway Dashboard ([Figure 122](#)), click **Features > Web Browser**. The default web browser window appears.



To change the default browser, see [Accessing System Controls](#) on page [78](#).

Becoming Meeting Moderator

VIA Campus² enables any authorized meeting participant to become a moderator (see [Configuring Moderator Mode](#) on page [31](#)). A meeting moderator has control over certain VIA functions that affect other participants, such as:

- [Streaming Video](#) on page [109](#).
- [Disabling Chat](#) on page [124](#).
- [Showing Participant Screen on Main Display](#) on page [124](#).



Moderator Mode must be activated to enable becoming a Moderator during a meeting (see [Configuring Moderator Mode](#) on page [31](#)).

To become the meeting moderator:

1. Click **Participants** on the user dashboard.

The Participants tab appears.



Figure 118: VIA Dashboard Participants Tab with Basic Moderator Mode Activated

2. Click **Become Moderator**.
3. When Basic Moderator Mode is active, type the password and click **Apply**. You are now the moderator.



To stop being the moderator, click **Leave Moderation**.

Disabling Chat

VIA Campus² enables the moderator of a meeting to disable the chat feature during a meeting.



To enable the Chat checkbox, see [Configuring Moderator Mode](#) on page [31](#)).

To disable chat:

1. Become the moderator of the meeting (see [Becoming Meeting Moderator](#) on page [123](#)).

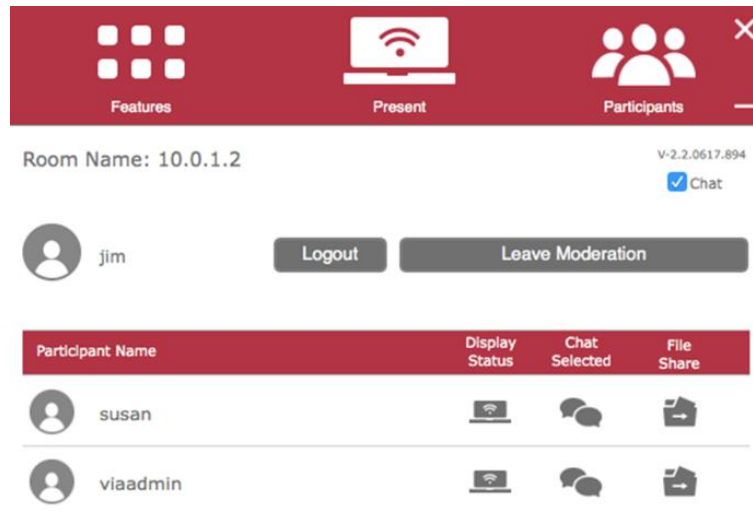

Figure 119: Kramer VIA app Dashboard participant's list

2. Clear the **Chat** checkbox at the top of the Participants list.
Chat is disabled.

Showing Participant Screen on Main Display

The moderator of a meeting can push a participant's screen onto the main display by clicking the Display Status icon of the participant in the Participant tab of the dashboard.

To show a participant screen on the main display:

1. Become the moderator of the meeting (see [Becoming Meeting Moderator](#) on page [123](#)).

- In the Participants list, click the icon in the Display Status column of the relevant participant.

The selected participant's screen is mirrored on the main display.

-  To add a message that enables the participant to either approve or deny permission to present their screen (see [Configuring Moderator Mode](#) on page 31).

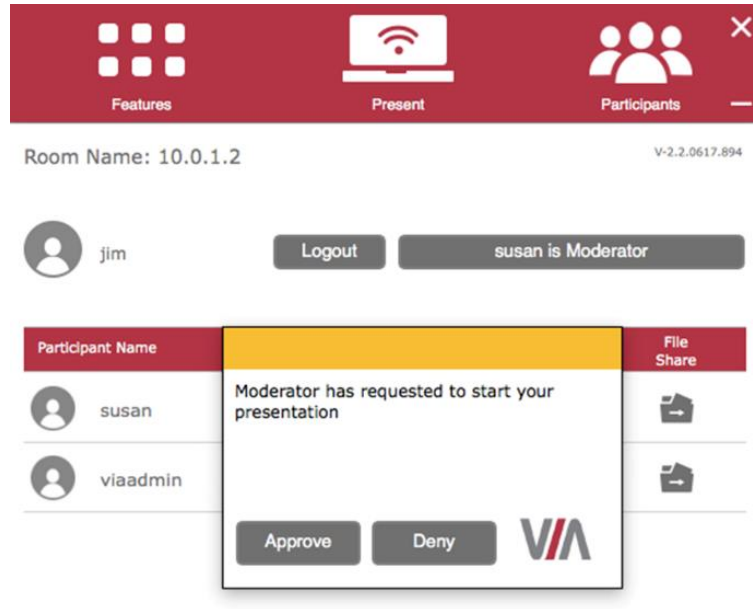

Figure 120: Participant's Screen with Presentation Request Confirmation Message

Allowing a Participant to Mirror on Main Display

The moderator of a meeting must give permission to any meeting participant who wants to mirror their screen on the main display.

To allow a participant to mirror on the main display:

- The participant clicks **Present**.
VIA Campus² sends a presentation request to the moderator. A preview of the participant's screen is displayed (for MAC/Windows users) to help the moderator accept or deny the request:

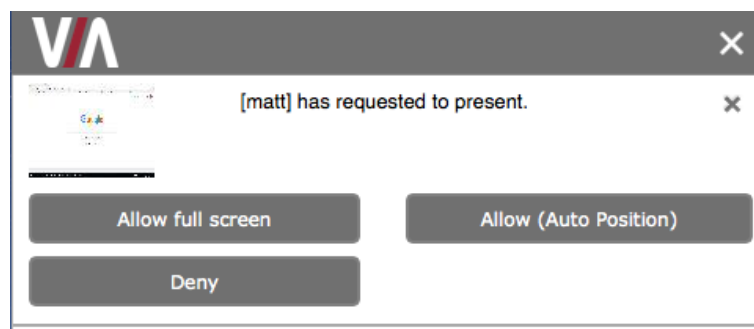



- The moderator clicks **Allow full screen** or **Allow (Auto Position)**.
The participant's presentation appears on the main display.

The participant receives the following message and their screen is mirrored on the main display.

-  The moderator can present at any time without permission.

Mirroring Main Display on Your Device

VIA Campus² enables you to mirror a live view of the main display on your device to obtain a closer look at the presentation and to add personal annotations to the content being presented.

-  You must stop presenting and/or streaming video to start the View Main Display feature.
-  View Main Display is designed for visual reinforcement and is displayed at a reduced frame rate in an effort to reduce bandwidth usage.

To mirror the main display on your device:

- Click the **View Main Display** icon on the Features menu of the VIA user dashboard ([Figure 78](#)).
A new window with a live representation of the main display and a toolbar (on the bottom for mobile devices or the left for laptops) appear on your screen.



Figure 121: View Main Display Window on a Laptop

- Zoom in and out of the image using one of the following methods:
 - On touchscreens: Pinch the screen.
 - On PCs & Macs: Click the +/- magnification icons in the upper right corner of your View Main Display window.
- Use the tool bar to perform the following basic whiteboarding activities:
 - Draw, erase, add notes and save the file.
 - Select color options.

- Create annotations that allow the user to take notes locally on their device without appearing on the presentation.
4. Click the **Switch Annotation** icon.
VIA saves your current screen and now, all annotations that you make appear on the main display.



Saved image captures are available under the Multimedia section of the VIA dashboard under “Documents”.

5. Click the **Switch Annotation** icon again.
VIA saves your current screen and all annotations that you make appear only on your screen.

To exit View Main Display:

- Click the **View Main Display** icon on the Features menu of the VIA Dashboard
OR
close the View Main Display window.

Advanced Meeting Functions

This section explains meeting functions that are performed by either the VIA administrator or a participant with moderator status.



The VIA administrator collaborates directly through the VIA unit by connecting a mouse and keyboard to the VIA gateway unit (see [For Installer: Connecting VIA Campus²](#) on page 8) or through a touchscreen interface.

Using Gateway Dashboard

The gateway dashboard is usually used by the VIA administrator who connects a mouse and keyboard directly to the VIA gateway unit (see [For Installer: Connecting VIA Campus²](#) on page 8) or through a touchscreen interface. However, this dashboard can also be accessed through an external device that is logged in to the meeting and in Collaboration mode (see [Collaborating on Main Display](#) on page 99).

To use the gateway dashboard:

1. Click the VIA logo in the upper right corner of the main display ([Figure 77](#)).
The administrator dashboard appears ([Figure 64](#)).

2. Click **Features**.

The gateway features appear.



Figure 122: Gateway Dashboard

Icon Name	Function
Features	Display all available features.
Whiteboard	Display a window and tools to annotate content on the main display.
Participants	Display a list of all participants in the session.
Cloud	Share files from VIA cloud with participants.
Screen Share	Present the main display on all participant devices.  This feature is called View Main Display in the User Dashboard.
Settings	Configure settings.
Reboot	Reboot the unit.
Shutdown	Shut down the unit.
Keyboard	Display a virtual keyboard that enables you to type using a mouse.

Showing Main Display on Participant Devices

VIA Campus² enables the administrator to show the main display on all meeting participant devices, so they can obtain a closer look at the presentation and add personal annotations to the content being presented.



The administrator can only share the main display with participants that are not presenting and/or streaming video.

To start showing the main display on participant devices:

- On the Administrator Dashboard ([Figure 122](#)), click the **Screen Share** feature icon. A check mark appears on the Screen Share icon and a new window with a live representation of the main display and a toolbar appear on the participant screens (see [Figure 121](#)).
For details about using the toolbar tools, see [Mirroring Main Display on Your Device](#) on page [126](#).

Changing Encoding Format

VIA Campus² enables you to change the default encoding format for your device. This is the encoding format used for presenting and streaming video from your device to **VIA Campus²** to be displayed on the main display. This change affects only your device.



The Web Administrator sets the default encoding format (see [Defining Default Encoding Format](#) on page [25](#)).

Two encoding formats are available:

- H. 264 – Default format if your operating system supports H. 264 encoding. This format reduces bandwidth requirements when presenting high-resolution content.
- JPEG – If the operating system does not support H. 264 encoding, enable this format.

To change the encoding format:

1. In your computer taskbar, click the VIA icon.
The taskbar menu appears ([Figure 99](#)).
2. Click **Settings** in the taskbar menu.
The Client Preferences screen appears ([Figure 100](#)).
3. Under Presentation Format Encoding, select the required encoding format.
The selected format is saved for future sessions.

Scaling User Dashboard for High Resolution Screen

The **Kramer VIA** app taskbar menu enables you enlarge your VIA dashboard when using a device with a 4K resolution screen.

To scale your dashboard when using a high resolution screen:

1. In your computer taskbar, click the VIA taskbar icon.
The taskbar menu appears ([Figure 99](#)).
2. Click **Settings** in the taskbar menu.
The Client Preferences screen appears ([Figure 100](#)).
3. Select the scaling option.
The dashboard is scaled.



This feature only appears in the taskbar menu when you are using a device with 4K resolution to connect to the meeting.

Recording a Meeting

VIA Campus² enables you to record all activity that appears on the main display during a meeting.



To activate this feature see [Activating Recording Feature](#) on page 41.

To manage recordings see [Managing Meeting Recordings](#) on page 42.

To record a meeting:

1. Click **Participants** on the user dashboard ([Figure 78](#)).
The Participants tab appears ([Figure 118](#)).
2. Click **Become Moderator** if Moderator mode is enabled.
3. Open the **Features** tab on the dashboard.

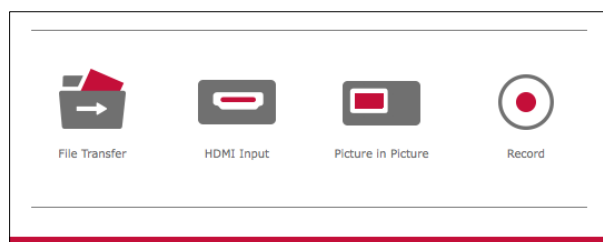

Figure 123: Record in Features Tab

1. Click **Record**.

The Record screen appears.

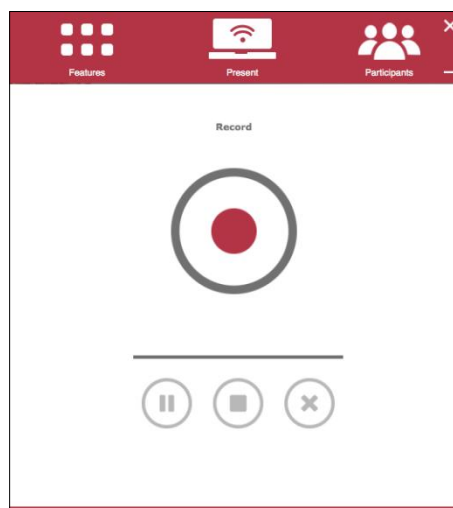

Figure 124: Record Screen

2. Click the large **Record** button to start recording the meeting.

3. Click the **Stop** button.

The Recording screen appears.

Figure 125: Recording Screen

4. Type a **Session Name** and **Description** for the recording.
5. Select the checkbox at the bottom of the screen to download a copy of this recording to your device.
6. Click **Save**.

The recording is saved on the system or on the USB drive connected to the **VIA Campus²**, depending on the settings selected by the administrator. To access saved recordings from the system, see [Managing Meeting Recordings](#) on page [42](#).

Streaming a Meeting Session

VIA Campus² enables you to stream all activity on the main display during a meeting to other VIA gateway units or computers.

VIA Campus² enables two types of streaming options:

- [Unicast Streaming](#) on page [131](#).
- [Multicast Streaming](#) on page [134](#).

Unicast Streaming

VIA Campus² can stream the main display to the following types of receivers:

- Another VIA Unit.
- Computer (Windows, Linux, Mac) which can run VLC player.

Creating a Unicast Streaming URL

To create a unicast streaming URL:

- Find the IP address of the receiver using one of the following methods:
 - Windows computers – Type ipconfig in the Command Prompt.
 - Mac computers – Type ipconfig in the Terminal.
 - Another VIA unit – Use the room name that appears on the Home screen.
- Use any allowed port number from 1 – 65536.
- Use the following format for a UDP URL:
 udp://<IP address>:<port number>/.
 Example: For a receiver with an IP address of 192.168.100.123 and an allowed port of 2234, the UDP URL is:
 udp://192.168.100.123:2234/
 OR
 Use the following format for an RTP URL:
 <rtp>:<ip>:<port>

Feeding Receiver Information to VIA Campus²

The receiver information must be fed to **VIA Campus²** before streaming can begin.

To feed receiver information to VIA Campus²:

- Click **VIA Management > VIA Settings** on the navigation pane ([Figure 7](#)).
The VIA Settings page appears ([Figure 8](#)).
- Click **Streaming**.

The Streaming tab appears.

VIA Settings

SYSTEM & IOS DISPLAY POWER DATE & TIME ADVANCED **STREAMING**

Streaming [?]

Streaming URL

Activate

Note: To change the Streaming URL the service must first be stopped. Then the URL can be changed and Streaming can be turned on again.

Note: Applied changes will take effect once the VIA is rebooted or the VIA session is reset.

Figure 126: VIA Settings > Streaming Tab

3. In the Streaming section, paste the receiver URL in the Streaming URL text box. The URL must be in the format explained in [Creating a Unicast Streaming URL](#) on page [132](#).
4. Under Activate, click **ON**.
Streaming is activated and the Streaming URL field is disabled.



To change the receiver URL while streaming:

1. Under Activate, click **OFF**.
2. Paste the new URL in the box and, under Activate, click **ON**.
The receiver URL is changed.

Streaming from one VIA Unit to Another VIA Unit

To stream from one VIA gateway unit (such as **VIA Campus²**) to another VIA unit, you need:

- Two VIA gateway units, one for a receiver and one for a sender.
- One Windows or Mac computer with the latest VIA client application installed.

To stream from one VIA unit to another VIA unit:

1. Connect the two VIA units and the computer to the same network.
2. Use the receiver VIA's room name to create a URL as described in [Creating a Unicast Streaming URL](#) on page [132](#).
3. On the computer, launch the VIA client application and log on to the sender VIA unit.
4. Take moderator rights if Moderator Mode is on.
5. Click the VIA icon in the computer taskbar and select **Start Streaming**.
6. On the computer, log out and log in to the receiver VIA unit.
7. In the Dashboard, click **Features > Multimedia**.
8. Click the Streaming tab.
9. Type an easily recognizable URL Name.
10. Type the TCP or UDP URL configured in [Creating a Unicast Streaming URL](#) on page [132](#).
11. Click **Add Media**.
The URL is added to the list.
12. Select the added URL and click **Play**.
Streaming begins from one VIA unit's display to the other VIA unit's display.

Streaming from a VIA Unit to a Windows/Mac Computer

To stream from one VIA gateway unit (such as **VIA Campus²**) to a Windows/Mac computer, you need:

- One VIA gateway unit, for a sender.
- One Windows or Mac computer with the latest VIA client application installed for a receiver.

To stream from one VIA unit to to a Windows/Mac computer:

1. Connect the VIA unit and the computer to the same network.

2. Use the receiver computer's IP address to create a URL as described in [Creating a Unicast Streaming URL](#) on page [132](#).
3. Use this URL on the VIA unit's web pages as explained in [Feeding Receiver Information to VIA Campus²](#) on page [132](#).
4. Log in to the VIA client application on the receiver computer.
5. Take moderator rights if Moderator Mode is on.
6. Click the VIA icon in the computer taskbar and select **Start Streaming**.
7. Launch VLC.
8. Click **Media > Open Network Stream**.
9. Type the streaming URL as `udp://@:<port number>`
Streaming begins and is displayed on the receiver computer.

Multicast Streaming

VIA gateway units (such as **VIA Campus²**) can stream their screens as a multicast so that multiple devices can view the gateway's display.

Creating a Multicast URL

To create a Multicast IP URL:

1. Select an IP address in the following range:
224. 0. 0. 0 to 239. 255. 255. 255
2. Select any allowed port number from 1–65536.
3. For example, for an IP address of 224. 0. 0. 5 and an allowed port of 2222, define the UDP URL as: `udp://224. 0. 0. 5:2222/`

Feeding Multicast IP Information to VIA Unit

To feed multicast information to the VIA unit:

1. Click **VIA Management > VIA Settings** on the navigation pane ([Figure 7](#)).
The VIA Settings page appears ([Figure 8](#)).
2. Click **Streaming**.
The Streaming tab appears ([Figure 126](#)).
3. Under the Streaming section, paste a URL in the Streaming URL text box in the format described in [Creating a Unicast Streaming URL](#) on page [132](#).
4. Under Activate, click **ON**.
Streaming is activated, and the Streaming URL field is disabled.



To change the receiver URL while streaming:

1. Under Activate, click **OFF**.
2. Paste the new URL in the box and, under Activate, click **ON**.
The receiver URL is changed.

Starting Multicast Stream

1. Launch the VIA client application on a Windows / Mac computer.
2. Make sure the client computer is on the same network as the VIA gateway.

3. Take moderator rights if Moderator Mode is on.
4. Click the VIA icon in this computer's taskbar and select **Start Streaming**.
The Multicast Stream starts.

Receiving a Multicast Stream on Multiple VIA Units

1. Login through the VIA Client to the target VIA unit.
2. On the dashboard, click **Features > Multimedia**.
3. Click the Streaming tab.
4. Type the streaming URL as `udp://@<IPAddress>:<port number>`
5. Click **Add Media**. The URL is added to the list.
6. Select the added URL and click **Play**.
Streaming begins from one VIA's display to another VIA gateway.



Repeat steps 1–6 to stream to another VIA unit.

Receiving Multicast Streams on Multiple Windows/Mac Computers

1. Launch VLC on the client computer.
2. Click **Media > Open Network Stream**.
3. Type the streaming URL as `udp://@<IPAddress>:<port number>`
Streaming starts from the VIA unit to the receiver computer.



Repeat steps 1–3 to stream to another computer.

Using Third Party Apps

VIA Campus² enables you to use third party apps that are installed on your VIA Campus² such as MS Office[®], Skype[®] and GoToMeeting[®] from the VIA dashboard.

To use a third party app installed on your VIA Campus² from the VIA dashboard:

1. On the VIA dashboard ([Figure 78](#)), click **Features > Third Party Apps**.
2. Double-click the required app.
The app appears.

Monitoring Bandwidth Usage

VIA Campus² enables you to monitor how much bandwidth you are using while communicating with VIA Campus².

To monitor bandwidth usage:

1. In your computer taskbar, click the VIA icon.
The taskbar menu appears ([Figure 99](#)).
2. Click **Settings** in the taskbar menu.
The Client Preferences screen appears ([Figure 100](#)).

3. Under Network Monitoring Tool, click the Activate Network Graph switch. Additional controls for the Network Monitoring Tool appear.
4. Click **Open Network Graph**.
The VIA Network Graph window appears. By default, the graph shows live bandwidth usage.
5. Select a date from the Session drop-down to see the graph from another session.
The graph of the session is played back as a video.

Setting Default Meeting Spaces List for Mobile App

When you start **Kramer VIA** mobile app, the Favorite Spaces screen appears, showing all meeting spaces that you have favorited. You can set the default screen to show the regular Meeting Spaces screen, which shows all discovered and saved meeting spaces, except for your favorites.

To set the default opening screen to the regular Meeting Spaces screen:

1. On the toolbar at the bottom of the Meeting Spaces screen ([Figure 79](#)), tap **Preferences**.

The Preferences screen appears.

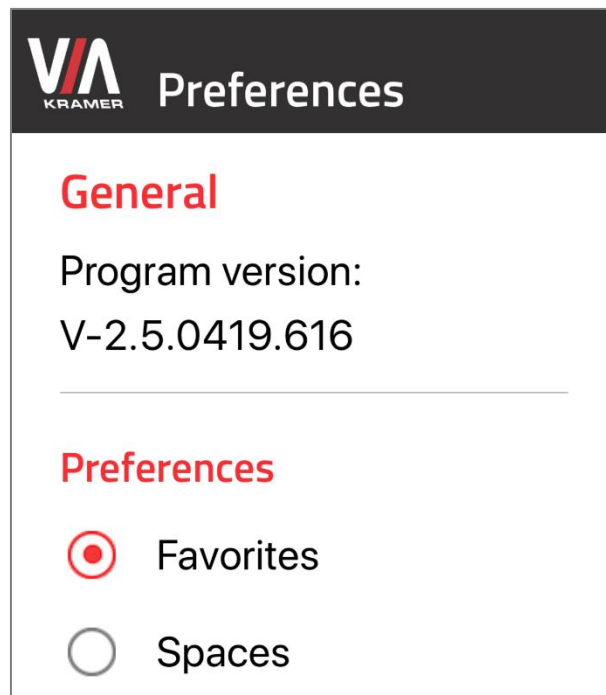

Figure 127: Preferences Screen for Mobile App

2. Select **Spaces**.
The default opening screen changes to Meeting Spaces.

Technical Specifications

Ports	2 USB 3.1 Gen 1 (blue)	On female USB type-A connectors
	3 USB 2.0 (black)	On female USB type-A connectors
	1 LAN	On an RJ-45 connector
	2 Wi-Fi Antennas	On threaded Wi-Fi connectors
	1 Power Toggle	On a 2-pin terminal block
Inputs	1 Microphone	On a 3.5mm jack
	1 HDMI (VIA Campus ² PLUS only)	On a female HDMI connector
Outputs	1 HDMI	On a female HDMI connector
	1 DisplayPort	On a female DisplayPort connector
	1 Unbalanced Stereo Audio Line Out	On a 3.5mm jack
Video	Max. Resolution HDMI Input	4K@60
	Max. Resolution DisplayPort Output	4K@60
	Max. Resolution HDMI Output	4K@30 (RGB)
	Video Streaming Playback (using Kramer VIA app Multimedia feature)	1080p@60fps
Audio	Integrated high definition audio	5.1 channel
General	Processor	3.60 GHz quad core (8th Generation)
	Main Memory	8GB (2 x 4GB DDR4 SDRAM modules)
	Storage	128GB, solid-state drive
	LAN	Gigabit LAN
Power	Source	120W power adapter (19V, 6.32A)
	Consumption	2.9A
Environmental Conditions	Operating Temperature	0° to +40°C (32° to 104°F)
	Storage Temperature	-40° to +70°C (-40° to 158°F)
	Humidity	10% to 90%, RHL non-condensing
Accessories	Included (VIA Campus ² , VIA Campus ² PLUS)	Power adapter, 2 Wi-Fi Antennas
	Included (VIA Campus ²)	HDMI cable extender (M to F)
Physical	Product Dimensions	21.00cm x 19.00cm x 5.00cm (8.27" x 7.48" x 1.97") W, D, H
	Product Weight	1.4kg (3.1lbs) approx.
	Shipping Dimensions	40.50cm x 29.70cm x 9.00cm (15.94" x 11.69" x 3.54") W, D, H
	Shipping Weight	2.77kg (6.1lbs) approx.
Specifications are subject to change without notice at www.kramerav.com		

The warranty obligations of Kramer Electronics Inc. ("Kramer Electronics") for this product are limited to the terms set forth below:

What is Covered

This limited warranty covers defects in materials and workmanship in this product.

What is Not Covered

This limited warranty does not cover any damage, deterioration or malfunction resulting from any alteration, modification, improper or unreasonable use or maintenance, misuse, abuse, accident, neglect, exposure to excess moisture, fire, improper packing and shipping (such claims must be presented to the carrier), lightning, power surges, or other acts of nature. This limited warranty does not cover any damage, deterioration or malfunction resulting from the installation or removal of this product from any installation, any unauthorized tampering with this product, any repairs attempted by anyone unauthorized by Kramer Electronics to make such repairs, or any other cause which does not relate directly to a defect in materials and/or workmanship of this product. This limited warranty does not cover cartons, equipment enclosures, cables or accessories used in conjunction with this product.

Without limiting any other exclusion herein, Kramer Electronics does not warrant that the product covered hereby, including, without limitation, the technology and/or integrated circuit(s) included in the product, will not become obsolete or that such items are or will remain compatible with any other product or technology with which the product may be used.

How Long this Coverage Lasts

The standard limited warranty for Kramer products is seven (7) years from the date of original purchase, with the following exceptions:

1. All Kramer VIA hardware products are covered by a standard three (3) year warranty for the VIA hardware and a standard three (3) year warranty for firmware and software updates; all Kramer VIA accessories, adapters, tags, and dongles are covered by a standard one (1) year warranty.
2. All Kramer fiber optic cables, adapter-size fiber optic extenders, pluggable optical modules, active cables, cable retractors, all ring mounted adapters, all Kramer speakers and Kramer touch panels are covered by a standard one (1) year warranty.
3. All Kramer Cobra products, all Kramer Calibre products, all Kramer Minicom digital signage products, all HighSecLabs products, all streaming, and all wireless products are covered by a standard three (3) year warranty.
4. All Sierra Video MultiViewers are covered by a standard five (5) year warranty.
5. Sierra switchers & control panels are covered by a standard seven (7) year warranty (excluding power supplies and fans that are covered for three (3) years).
6. K-Touch software is covered by a standard one (1) year warranty for software updates.
7. All Kramer passive cables are covered by a ten (10) year warranty.

Who is Covered

Only the original purchaser of this product is covered under this limited warranty. This limited warranty is not transferable to subsequent purchasers or owners of this product.

What Kramer Electronics Will Do

Kramer Electronics will, at its sole option, provide one of the following three remedies to whatever extent it shall deem necessary to satisfy a proper claim under this limited warranty:

1. Elect to repair or facilitate the repair of any defective parts within a reasonable period of time, free of any charge for the necessary parts and labor to complete the repair and restore this product to its proper operating condition. Kramer Electronics will also pay the shipping costs necessary to return this product once the repair is complete.
2. Replace this product with a direct replacement or with a similar product deemed by Kramer Electronics to perform substantially the same function as the original product.
3. Issue a refund of the original purchase price less depreciation to be determined based on the age of the product at the time remedy is sought under this limited warranty.

What Kramer Electronics Will Not Do Under This Limited Warranty

If this product is returned to Kramer Electronics or the authorized dealer from which it was purchased or any other party authorized to repair Kramer Electronics products, this product must be insured during shipment, with the insurance and shipping charges prepaid by you. If this product is returned uninsured, you assume all risks of loss or damage during shipment. Kramer Electronics will not be responsible for any costs related to the removal or re-installation of this product from or into any installation. Kramer Electronics will not be responsible for any costs related to any setting up this product, any adjustment of user controls or any programming required for a specific installation of this product.

How to Obtain a Remedy Under This Limited Warranty

To obtain a remedy under this limited warranty, you must contact either the authorized Kramer Electronics reseller from whom you purchased this product or the Kramer Electronics office nearest you. For a list of authorized Kramer Electronics resellers and/or Kramer Electronics authorized service providers, visit our web site at www.kramerav.com or contact the Kramer Electronics office nearest you.

In order to pursue any remedy under this limited warranty, you must possess an original, dated receipt as proof of purchase from an authorized Kramer Electronics reseller. If this product is returned under this limited warranty, a return authorization number, obtained from Kramer Electronics, will be required (RMA number). You may also be directed to an authorized reseller or a person authorized by Kramer Electronics to repair the product.

If it is decided that this product should be returned directly to Kramer Electronics, this product should be properly packed, preferably in the original carton, for shipping. Cartons not bearing a return authorization number will be refused.

Limitation of Liability

THE MAXIMUM LIABILITY OF KRAMER ELECTRONICS UNDER THIS LIMITED WARRANTY SHALL NOT EXCEED THE ACTUAL PURCHASE PRICE PAID FOR THE PRODUCT. TO THE MAXIMUM EXTENT PERMITTED BY LAW, KRAMER ELECTRONICS IS NOT RESPONSIBLE FOR DIRECT, SPECIAL, INCIDENTAL OR CONSEQUENTIAL DAMAGES RESULTING FROM ANY BREACH OF WARRANTY OR CONDITION, OR UNDER ANY OTHER LEGAL THEORY. Some countries, districts or states do not allow the exclusion or limitation of relief, special, incidental, consequential or indirect damages, or the limitation of liability to specified amounts, so the above limitations or exclusions may not apply to you.

Exclusive Remedy

TO THE MAXIMUM EXTENT PERMITTED BY LAW, THIS LIMITED WARRANTY AND THE REMEDIES SET FORTH ABOVE ARE EXCLUSIVE AND IN LIEU OF ALL OTHER WARRANTIES, REMEDIES AND CONDITIONS, WHETHER ORAL OR WRITTEN, EXPRESS OR IMPLIED. TO THE MAXIMUM EXTENT PERMITTED BY LAW, KRAMER ELECTRONICS SPECIFICALLY DISCLAIMS ANY AND ALL IMPLIED WARRANTIES, INCLUDING, WITHOUT LIMITATION, WARRANTIES OF MERCHANTABILITY AND FITNESS FOR A PARTICULAR PURPOSE. IF KRAMER ELECTRONICS CANNOT LAWFULLY DISCLAIM OR EXCLUDE IMPLIED WARRANTIES UNDER APPLICABLE LAW, THEN ALL IMPLIED WARRANTIES COVERING THIS PRODUCT, INCLUDING WARRANTIES OF MERCHANTABILITY AND FITNESS FOR A PARTICULAR PURPOSE, SHALL APPLY TO THIS PRODUCT AS PROVIDED UNDER APPLICABLE LAW. IF ANY PRODUCT TO WHICH THIS LIMITED WARRANTY APPLIES IS A "CONSUMER PRODUCT" UNDER THE MAGNUSON-MOSS WARRANTY ACT (15 U.S.C.A. §2301, ET SEQ.) OR OTHER APPLICABLE LAW, THE FOREGOING DISCLAIMER OF IMPLIED WARRANTIES SHALL NOT APPLY TO YOU, AND ALL IMPLIED WARRANTIES ON THIS PRODUCT, INCLUDING WARRANTIES OF MERCHANTABILITY AND FITNESS FOR THE PARTICULAR PURPOSE, SHALL APPLY AS PROVIDED UNDER APPLICABLE LAW.

Other Conditions

This limited warranty gives you specific legal rights, and you may have other rights which vary from country to country or state to state.

This limited warranty is void if (i) the label bearing the serial number of this product has been removed or defaced, (ii) the product is not distributed by Kramer Electronics or (iii) this product is not purchased from an authorized Kramer Electronics reseller. If you are unsure whether a reseller is an authorized Kramer Electronics reseller, visit our web site at www.kramerav.com or contact a Kramer Electronics office from the list at the end of this document.

Your rights under this limited warranty are not diminished if you do not complete and return the product registration form or complete and submit the online product registration form. Kramer Electronics thanks you for purchasing a Kramer Electronics product. We hope it will give you years of satisfaction.



S



P/N:



2900-301213

Rev:



2



SAFETY WARNING

Disconnect the unit from the power supply before opening and servicing

For the latest information on our products and a list of Kramer distributors, visit our Web site where updates to this user manual may be found.

We welcome your questions, comments, and feedback.

The terms HDMI, HDMI High-Definition Multimedia Interface, and the HDMI Logo are trademarks or registered trademarks of HDMI Licensing Administrator, Inc. All brand names, product names, and trademarks are the property of their respective owners.